



Ultra lightweight activity wheelchair in carbon design, suitable for (very) small and/or weak children (already from 12 months)

Included in the base price:

- Complete Carbon package: Curved back plate, seat plate, side guards and foot plate
- Frame versions Retro or Taurus
- Super light weight wheels
- 2 different V-shaped abductions for maximized leg space
- adjustable back angle (80° -100°)
- Grows with the patient (SW + 2 cm, SD max. +4 cm, BH max. 5 cm), purchased parts may be necessary (depending on configuration)
- Activity side guards with integrated bowden cable brake.
- Also included: stabilizer bar; Caster wheels with aluminum fork; wheel cover

Not suitable as a seat for the transport in a passenger vehicle!

- Quotation
 Order

Weight capacity: 50 kg

Base price 6.595,- €

Prices excl. VAT,
valid from 07.01.2025 and until further notice.

Delivery address / Company stamp		Billing address: <input type="checkbox"/> same as delivery address	
Name:		Name:	
Address:		Address:	
Ordering information:			
Reference/ internal description:		Date:	
Contact person:		Signature:	

Frame measures					
Seat width 10..		Seat depth 11..		Back height 12..	
+ 2 cm extension each		+ 4 cm extension each		+ 2,5 / + 5 cm extension each (depending on the configuration)	
<input type="checkbox"/> 18	<input type="checkbox"/> 20	<input type="checkbox"/> 18	<input type="checkbox"/> 20	<input type="checkbox"/> 17,5	<input type="checkbox"/> 20
<input type="checkbox"/> 22	<input type="checkbox"/> 24	<input type="checkbox"/> 22	<input type="checkbox"/> 24	<input type="checkbox"/> 22,5	<input type="checkbox"/> 25
<input type="checkbox"/> 26	<input type="checkbox"/> 28	<input type="checkbox"/> 26	<input type="checkbox"/> 28	<input type="checkbox"/> 27,5	<input type="checkbox"/> 30
<input type="checkbox"/> 30		<input type="checkbox"/> 30		<input type="checkbox"/> 32,5	<input type="checkbox"/> 35

Seat heights							
Caster size	Wheel size	Bore holes (B) caster fork	Seat height front Measured WITHOUT cushion. All specifications ±5 %				
4"	18"	in 18"-fork	<input type="checkbox"/> 32 cm	<input type="checkbox"/> 33,5 cm	<input type="checkbox"/> 35 cm	-	-
	20"	B2	<input type="checkbox"/> 34 cm	<input type="checkbox"/> 35,5 cm	<input type="checkbox"/> 37 cm	<input type="checkbox"/> 38,5 cm	<input type="checkbox"/> 40 cm
	22"	B2	<input type="checkbox"/> 36 cm	<input type="checkbox"/> 37,5 cm	<input type="checkbox"/> 39 cm	<input type="checkbox"/> 40,5 cm	<input type="checkbox"/> 42 cm
	24"	B2	<input type="checkbox"/> 38,5 cm	<input type="checkbox"/> 40 cm	<input type="checkbox"/> 41,5 cm	<input type="checkbox"/> 43 cm	<input type="checkbox"/> 44,5 cm
5"	20"	B1	<input type="checkbox"/> 34 cm	<input type="checkbox"/> 35,5 cm	<input type="checkbox"/> 37 cm	<input type="checkbox"/> 38,5 cm	<input type="checkbox"/> 40 cm
	22"	B1	<input type="checkbox"/> 36 cm	<input type="checkbox"/> 37,5 cm	<input type="checkbox"/> 39 cm	<input type="checkbox"/> 40,5 cm	<input type="checkbox"/> 42 cm
	24"	B1	<input type="checkbox"/> 38,5 cm	<input type="checkbox"/> 40 cm	<input type="checkbox"/> 41,5 cm	<input type="checkbox"/> 43 cm	<input type="checkbox"/> 44,5 cm

Bore holes

B1 = 5"

B2 = 4"

Specification of lower leg length (LLL) / Cushion thickness / Distance			
Specify: Lower leg length (LLL)	Specify: Cushion thickness	Result Distance upper edge of the seat and the upper edge of the footplate - Cushion thickness	
<input style="width: 100px; height: 30px;" type="text"/>	<input style="width: 100px; height: 30px;" type="text"/>	-	=
<input style="width: 100px; height: 30px;" type="text"/>			
All measurements in cm			
Lower leg length: Specification of the distance in cm between the hollow of the knee and the sole of the foot at a 90° knee position angle		Thickness seat cushion: Indication of the thickness of the planned seat cushion	
Wheelchair Dimensions: Distance from the upper edge of the seat to the upper edge of the footrest in cm (without taking into account the thickness of the seat cushion). From your information regarding the lower leg length and thickness of the seat cushion, we calculate the distance from the top edge of the seat to the top edge of the footrest and mount this on the leg support you have chosen.		Measuring example: Your information: LLL = 38 cm, seat cushion thickness = 5 cm Manufacturer assembly: In this example, SORG mounts the footrest at a distance of 33 cm from the footrest.	

Distance selection Maximum distance from the top edge of the seat to the top edge of the footrest (depending on the seat height)

Check your configuration based on the wheelchair dimensions determined above. Mark the desired setting range in the table below. The specified dimension is the maximum adjustable distance between the upper edge of the seat and the upper edge of the footrest (depending on the seat height).
 Correct marking of the desired distance (Distance determined under leg support configuration, see above). Necessary test steps:

1 Selection Frame form → 2 Selection Frame version → 3 Selection wheel size → 4 Selection seat depth

1 Frame form Taurus					1 Frame form RETRO				
Size caster wheel	4 inches	5 inches	4 inches	5 inches	Size caster wheel	4 inches	5 inches	4 inches	5 inches
Frame version	Taurus frame version with strong abduction		Taurus frame version with slight abduction		Frame version	Retro frame version with strong abduction		Retro frame version with slight abduction	
4 Seat depth	Size rear wheel 18 inches / 20 inches 3				4 Seat depth	Size rear wheel 18 inches / 20 inches 3			
18 - 24 cm	<input type="checkbox"/> ≤ 29,5 cm		<input type="checkbox"/> ≤ 24,5 cm	<input type="checkbox"/> ≤ 22 cm	18 - 24 cm	<input type="checkbox"/> ≤ 28,5 cm		<input type="checkbox"/> ≤ 22,5 cm	<input type="checkbox"/> ≤ 21,5 cm
26 - 30 cm	<input type="checkbox"/> ≤ 28 cm	<input type="checkbox"/> ≤ 25 cm	<input type="checkbox"/> ≤ 24 cm	<input type="checkbox"/> ≤ 22 cm	26 - 30 cm	<input type="checkbox"/> ≤ 30 cm	<input type="checkbox"/> ≤ 25,5 cm	<input type="checkbox"/> ≤ 20 cm	<input type="checkbox"/> ≤ 20 cm
22 inches					22 inches				
18 - 24 cm	<input type="checkbox"/> ≤ 31 cm		<input type="checkbox"/> ≤ 26,5 cm	<input type="checkbox"/> ≤ 24 cm	18 - 24 cm	<input type="checkbox"/> ≤ 31 cm		<input type="checkbox"/> ≤ 25,5 cm	<input type="checkbox"/> ≤ 23 cm
26 - 30 cm	<input type="checkbox"/> ≤ 31,5 cm		<input type="checkbox"/> ≤ 24 cm	<input type="checkbox"/> ≤ 24 cm	26 - 30 cm	<input type="checkbox"/> ≤ 30 cm		<input type="checkbox"/> ≤ 24,5 cm	<input type="checkbox"/> ≤ 20,5 cm
24 inches					24 inches				
18 - 24 cm	<input type="checkbox"/> ≤ 32 cm		<input type="checkbox"/> ≤ 31 cm	<input type="checkbox"/> ≤ 28,5 cm	18 - 24 cm	<input type="checkbox"/> ≤ 31 cm		<input type="checkbox"/> ≤ 29 cm	<input type="checkbox"/> ≤ 27 cm
26 - 30 cm	<input type="checkbox"/> ≤ 33 cm		<input type="checkbox"/> ≤ 28 cm	<input type="checkbox"/> ≤ 26,5 cm	26 - 30 cm	<input type="checkbox"/> ≤ 30,5 cm		<input type="checkbox"/> ≤ 27,5 cm	<input type="checkbox"/> ≤ 25,5 cm



Attention. All information can be increased by up to 4.5 cm (in 3 x 1.5 cm steps) above the seat height by moving the seat plate up. The increase in size affects the seat height.

Frame versions			
Taurus-Frame N° 597304		Retro-Frame N° 597301	
<input type="checkbox"/> Taurus Strong abduction		<input type="checkbox"/> Retro Strong abduction	
casters on one line with rear wheels		casters on one line with rear wheels	
<input type="checkbox"/> Taurus Slight abduction		<input type="checkbox"/> Retro Slight abduction	
casters narrower than rear wheels		casters narrower than rear wheels	
N° 597305	0,- €	N° 597306	0,- €

Carbon Elements
Complete Carbon package
Curved back plate, seat plate, side guards and foot plate made of lightweight and highly stable carbon
<i>configuration on the following pages</i>
N° 167302
0,- €

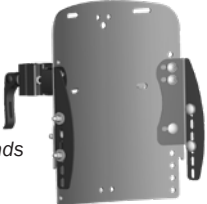
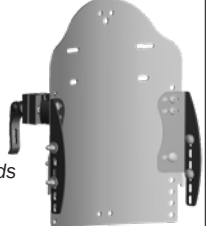
Frame colors and color anodization Design package			
Finish alternatives	Moderate metallic effect	Not metallic	Special colors (without additional charge, except for Nightblue)
<input type="checkbox"/> Shiny	<input type="checkbox"/> Cream white (17)	<input type="checkbox"/> Black (31)	strong metallic effect:
incl.	<input type="checkbox"/> Zinc yellow (02)		<input type="checkbox"/> Silver metallic (36)
<input type="checkbox"/> Matt	<input type="checkbox"/> Chrome yellow (06)		Coarse structured surface:
Not possible with special colors!	<input type="checkbox"/> Pure orange (21)		<input type="checkbox"/> Coarse black (27)
N° 1561	<input type="checkbox"/> Crimson (04)		Dormant colors:
99,- €	<input type="checkbox"/> Pink (19)		<input type="checkbox"/> Firered Dormant (45)
	<input type="checkbox"/> Pastel blue (20)		<input type="checkbox"/> Violet Dormant (50)
	<input type="checkbox"/> Brilliant blue (08)		Dormant color with additional charge AC 99,-€
	<input type="checkbox"/> Dark blue (16)		<input type="checkbox"/> Nightblue Dorm. (47)
	<input type="checkbox"/> Dark green (15)		
	<input type="checkbox"/> Goblin green (33)		
	<input type="checkbox"/> Brown grey (35)		
	<input type="checkbox"/> King's blue (32)		
Design package color anodization (Color examples for anodized colors can be found on our website in the area equipment)			
<input type="checkbox"/> anodized Blue (01)	The following parts are anodized: Caster forks, hand rims, brake bar and push handle bar		Restrictions:
<input type="checkbox"/> anodized Red (02)	The design package ist only possible in the listed setting.		The hand rims are only available in the design package anodized colors by choosing aluminum hand rims. (Not possible with stainless steel, Maxgrepp, PVC, double or nob hand rims. Also not possible with profile wheels).
<input type="checkbox"/> anodized Green (03)			
<input type="checkbox"/> anodized Gold Orange (04)			
<input type="checkbox"/> anodized Violet (05)			
N° 1569..	CPD 235,- €		



Seat system		Curved back plate			
Seat plate	Model 1	Model 3	Back angle		
<input checked="" type="checkbox"/> Seat plate made of carbon, seat height, -depth and -inclination adjustable by seat support frame Required configuration: <input type="checkbox"/> no seat inclination <input type="checkbox"/> slight seat inclination <input type="checkbox"/> high seat inclination	Curved back plate made of carbon, BH + 2 cm (straight) <input type="checkbox"/> 20-30 mm curve depth, growable! <i>curve depth depends on the selected seat width</i> 	Curved back plate made of carbon, BH + 5 cm (curved) <input type="checkbox"/> 20-30 mm curve depth, growable! <i>curve depth depends on the selected seat width</i> 	<input type="checkbox"/> Adjustable from 80° - 100° (in 5°-steps) incl. stabilizer bar Standard configuration: 90° Desired back angle: <input type="checkbox"/> _____°		
N° 193079	0,- €	N° 697901	0,- €	N° 697902	199,- €
				N° 697800	0,- €



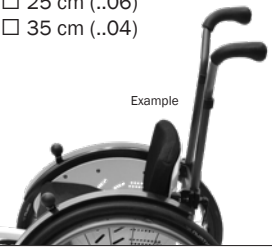

Seat cushions (all covers with zippers and changeable)				
	Standard cushion	Anatomical cushion	Cover design	Incontinence cover
<input type="checkbox"/> No seat cushion (please tick if no cushion is required)	Synthetic foam for firm and comfortable seating <input type="checkbox"/> 3 cm (...03) <input type="checkbox"/> 5 cm (...05) 	<input type="checkbox"/> Anatomically formed, with slight abduction, changeable cover (Thickness of the front upholstery, depending on cushion size, is 5-6 cm) 	in selected cover color (color choice and color code see below) -> Choice of cover color	<input type="checkbox"/> For standard cushion as chosen on the left
	N° 80.. 105,- €	N° 891002 CPD 499,- €	N° 80..	N° 86.. 105,- €
<input type="checkbox"/> Additional cover for cushion as chosen on the right	Pressure relief cushion for medium-soft seating <input type="checkbox"/> 3 cm (...03) <input type="checkbox"/> 5 cm (...05)	<input type="checkbox"/> Additional cover for anatomical cushion as chosen	<input type="checkbox"/> Seat cushion as chosen, without cover	<input type="checkbox"/> For anatomical cushion as chosen on the left
N° 8201 85,- €	N° 81.. 135,- €	N° 891003 CPD 186,- €	N° 998001 ./ . 30,- €	N° 891004 CPD 195,- €

Back cushions (all covers with zippers and changeable)			
No cushion	Standard cushion	Anat. back cushion	Cover design
<input type="checkbox"/> No back cushion (please tick if no cushion is required)	<input type="checkbox"/> Medium-soft cushion, foam plastic, 3 cm, with zipper, changeable cover	<input type="checkbox"/> Anatomically formed, incl. changeable cover, cavity 3 cm Only with curved back plate Customized product	in selected cover color (color choice and color code see below) -> Choice of cover color
	N° 8501 85,- €	N° 8517 165,- €	N° 85..
<input type="checkbox"/> Additional cover for cushion as chosen on the right		<input type="checkbox"/> Additional cover for anatomical back cushion as chosen	<input type="checkbox"/> Back cushion as chosen, without cover
		N° 891110 CPD 175,- €	N° 998501 ./ . 30,- €



Choice of Trevira cover color	
Note: Color views may differ from reality depending on the screen view / printout and are only for initial orientation.	
Please choose the color of the selected covers:	
<input type="checkbox"/> black (30) <input type="checkbox"/> grey (31) <input type="checkbox"/> nightblue (32) <input type="checkbox"/> ultramarine blue (33) <input type="checkbox"/> petrol (34) <input type="checkbox"/> applegreen (35) <input type="checkbox"/> burgundy (36) <input type="checkbox"/> red (37) <input type="checkbox"/> pink (38)	
	
N° 80.. (seat cushion/anat. cushion)	N° 85.. (back cushion/anat. back cushion)

Leg support	
<input checked="" type="checkbox"/> Model 1 Foot plate made of carbon, undivided, adjustable in height, depth and angle	
N° 402679	0,- €





Push handles		
Extendable standard push handles	Push bow	
Push handles extendable by straight: (recommended from SW26) <input type="checkbox"/> 25 cm (..02) <input type="checkbox"/> 35 cm (..03) cranked: <input type="checkbox"/> 25 cm (..06) <input type="checkbox"/> 35 cm (..04)	<input type="checkbox"/> Extendable push handle with LONG handle (configure extension on the left)	<input type="checkbox"/> extendable by 20 cm, adjustable in angle joint made of plastic at SW20/22 and BH25/30 only limited height adjustment possible
	<input type="checkbox"/> Extendable push handle with SHORT handle (configure extension on the left)	
	N° 65.. 264,-€/P	
N° 65..+ N° 623702 294,-€/P		

Side guard	User brakes	Companion brake	
Standard Carbon	Bowden cable brake	Lockable user brake	Locking brake
<input checked="" type="checkbox"/> Carbon side guard with integrated wheel cover	<input type="checkbox"/> Bowden cable brake, integrated in activity side guards, with ball knob	<input type="checkbox"/> Bowden cable brake, lockable in activated or deactivated position , integrated in activity side guards, with ball knob	<input type="checkbox"/> Locking brake at the back of the rear wheels To lock in the resting state (No driving brake) Not in combination with drum brake (N° 220036)
			
N° 502579 0,- €/P	N° 353601 0,- €	N° 353603 390,- €/P	N° 353602 340,- €





Wheel size and wheel camber			Wheels
Wheel size (sizes in inches)	Wheel camber	Super lightweight wheel	
<input type="checkbox"/> 18" - 18" only for lightweightwheels with standard hub, - 18" only up to seat depth 22) <input type="checkbox"/> 20" <input type="checkbox"/> 22" <input type="checkbox"/> 24"	Wheel camber, firmly welded <input type="checkbox"/> 9°	Assembly set camber 7°/11°, preinstalled for <input type="checkbox"/> 7° <input type="checkbox"/> 11°	<input checked="" type="checkbox"/> 200g/pair lighter than a lightweight wheel, incl. aluminum handrims
0,- €	0,- €	N° 201516 80,- €	N° 21..78 0,- €

Tyres	Handrim	
Standard	Performance	Ergonomic
Pneumatic: <input type="checkbox"/> Schwalbe Right Run 1" (..13)	Pneumatic: <input type="checkbox"/> Schwalbe Marathon Plus, pneumatic flat free tyres, 1" Only for 22" and 24" wheels	<input type="checkbox"/> tight <input type="checkbox"/> wide handrim with ergonomic handrim profile, black anodized with built-in rubber grip only for 24" wheels
		
N° 20.. 0,- €	N° 20..12 76,- €/P	N° 342424 420,- €/P

Spoke cover	Design spoke cover decors	
Transparent	Design spoke covers Please specify the desired model of the corresponding manufacturer:	
<input type="checkbox"/> transparent (..00)	<input type="checkbox"/> www.speichen-schutz.de	<input type="checkbox"/> www.wheelchairgadgets.com
N° 25.. 172,- €/P	N° 25..26 TD 180,- €	N° 25..27 TD 180,- €

Caster wheels			
Standard PU	Design PU	Standard solid rubber	Design solid rubber
Polyurethane, black: <input type="checkbox"/> 5" N°281515 Width 26 mm <input type="checkbox"/> 5" N°281505 Width 37 mm Example: 	Polyurethane, transparent, with LEDs: <input type="checkbox"/> 4" N°282004 Width 25 mm <input type="checkbox"/> 5" N°282005 Width 25 mm With 18" rear wheels only 4" caster wheels possible Example: 	Solid rubber, grey: <input type="checkbox"/> 4" N°281004 Width 32 mm <input type="checkbox"/> 5" N°281005 Width 40 mm With 18" rear wheels only 4" caster wheels possible Example: 	Solid rubber, black, with aluminum rim: <input type="checkbox"/> 4" N°283904 Width 35 mm <input type="checkbox"/> 5" N°283905 Width 35 mm With 18" rear wheels only 4" caster wheels possible Example: 
0,- €	0,- €	0,- €	0,- €

Caster forks	
Standard Aluminum	Design Aluminum
<input type="checkbox"/> Alu fork, black anodized  N° 2826 0,- €	<input type="checkbox"/> Aluminum fork coated in frame color color N°: _____ The color numbers can be found next to the frame colors on page 2. Without specifying a color number, the selected frame color is used for coating. Anodized colors are only possible in the design package. N° 2829 TD 70,- €/P

Frame options			
Anti-tipper	Outdoor Front End	Splash guard	Bumper
Swing-away installation Mounting <input type="checkbox"/> left <input type="checkbox"/> right <input type="checkbox"/> pair (from SW 22) 	<input type="checkbox"/> Outdoor Front End, facilitates significantly active and passive driving on soft or rough surfaces, incl. mounting aid 	<input type="checkbox"/> Splash guard for Outdoor Front End, made of plastic 	<input type="checkbox"/> Bumper, made of rubber to protect furniture, doors, etc. 
N° 7213 175,- €/Pcs	N° 599517 CPD 479,- €	N° 59951212 CPD 85,- €	N° 9102 TD 80,- €

Sun shade
<input type="checkbox"/> variable adjustable sun shade (size 1), in black Usable height (from the top edge of the seat plate/seat cover to the apex) = selected back height + 40 cm Example: BH 30 + 40 cm = 70 cm  Removable sun shade. Easily adjustable in height and position by flexible holder.
N° 910301 TD 250,- €

To see the latest versions of our order forms, please visit www.sorgrollstuhltechnik.de/download-portal

Lightweight head rests Measures in mm (all measures ± 10mm)

Lightweight head rest, adjustable with two conical joints, connection and removable cover included. (cover with same color as back cushion)
Weight reduction approximately 700-1000g to standard head rest systems.

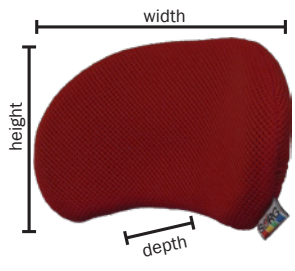

Pad sizes:



	size 1	size 2
height	110	130
width	200	260
depth	30	40

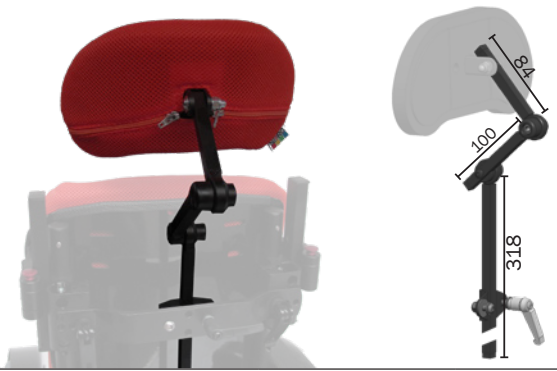

Not approved as a headrest for transport in a motor vehicle.







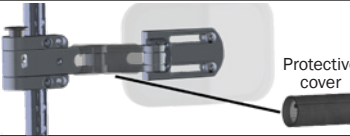

Article name	Article-N°	Price
<input type="checkbox"/> Lightweight head rest Size 1 (Pad size 110x200mm)	N° 68600920	325,- €
<input type="checkbox"/> Lightweight head rest Size 2 (Pad size 130x260mm)	N° 68600921	325,- €

Lateral support (from back height 30: Extension possible without restrictions)

Article name	Article-N°	Price
Pad for pad holder Size 1		
<input type="checkbox"/> Pad 10 x 7 cm (incl. cover)	 N° 68590104	CPD 116,- €/P
<input type="checkbox"/> Pad 10 x 9 cm (incl. cover)	 N° 68590105	CPD 116,- €/P
<input type="checkbox"/> Pad 12 x 9 cm (incl. cover)	 N° 68590106	CPD 116,- €/P

<input type="checkbox"/> Lateral support holder, adjustable Adjustable holder for lateral support, incl. linkage and protective cover Without pad		N° 68590200	CPD 420,- €/P
<input type="checkbox"/> Extension joint for foldable pad holder Extension for: Holder Size 1 (3,8cm)		N° 68590115	CPD 124,- €/P

Positioning belts

Article name	Article-N°	Price
<input type="checkbox"/> 2-Point pelvic belt with PLASTIC fastener, incl. mounting material for self attachment	 N° 780590	140,- €
<input type="checkbox"/> 2-Point pelvic belt with METAL fastener, incl. mounting material for self attachment	 N° 780591	155,- €
<input type="checkbox"/> 4-Point pelvic belt with PLASTIC fastener, incl. mounting material for self attachment	 N° 780592	180,- €
<input type="checkbox"/> 4-Point pelvic belt with METAL fastener, incl. mounting material for self attachment	 N° 780593	195,- €
<input type="checkbox"/> Protection cap for pelvic belt with metal fastener (see N° 780591 oder N° 780593) Makes independent opening for the patient difficult.	 N° 78050210	20,- €
<input type="checkbox"/> Chest-shoulder belt without zipper, incl. mounting material for self attachment	 N° 781010	199,- €

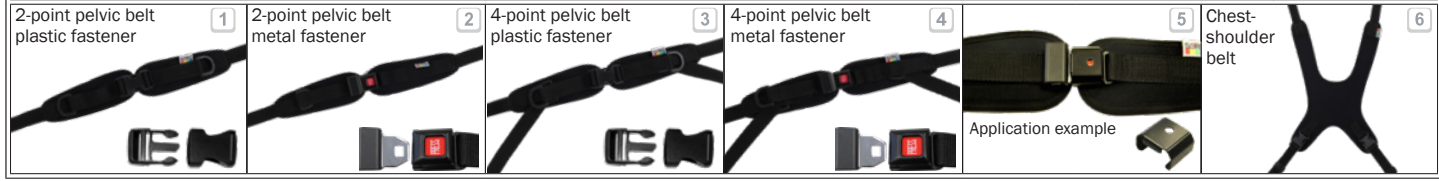

Abbreviations:

piece - pcs	seat width - SW	lower leg length - LLL
pair - P	seat depth - SD	customized product discount - CPD
trade discount - TD	back height - BH	Additional charge - AC
configuration - cf.		

Notes:

To see the latest versions of our order forms, please visit www.sorgrollstuhltechnik.de/download-portal

Terms and Conditions

1. Preface and Scope

(1) Our terms and conditions apply exclusively. Any deviating, opposing, or complementing terms and conditions on the part of the business partner do not form integral part of contract unless explicitly approved of by us. There are no exceptions to the consent requirement, which also applies in cases where we conduct deliveries without restrictions while aware of the business partner's terms and conditions.
(2) Agreements made in the individual case with the purchaser (including side-agreements, supplements, and alterations) always take priority over these terms and conditions. A contract or our confirmation - both in written form - are authoritative for the content of such arrangements.
(3) Any legally relevant declarations and notifications the purchaser submits to us after conclusion of the contract (e.g. setting of deadlines, notice of defects, declarations of rescission or abatement) require the written form to be valid.
(4) Any information on the application of legal regulations serves the mere purpose of clarification. All regulations are legally binding without any such clarifications unless explicitly altered or excluded in these terms and conditions.

2. Prices

All prices are ex works, excluding insurance and packaging. The prices are net prices; the value-added tax is stated and charged separately according to the legally binding rate at the time of invoicing. The prices valid on the day of delivery are binding unless explicitly arranged otherwise.

3. Conclusion of Contract

SORG's offers are invitatio ad offerendum (invitations to treat). Ordering goods counts as an obligatory offer of contract on the part of the purchaser. Unless the order suggests otherwise, we have the right to accept this contract offer within two weeks time after reception. The acceptance of an offer of contract is effected by the confirmation of the order.

4. Terms of Payment

(1) Provided that no other agreements exist, payment is to be made by paying in advance -50% at placing of order, 50% pre-delivery of goods. The purchaser bears any costs arising from transactions or discounting.
(2) If a 30-day payment deadline is exceeded, a delay rate of 9% on top of the respective base rate of the European Central Bank falls due without the need for prior notices. Beyond that, the purchaser is charged 3,- € for any reminder sent. We reserve the right to make use of the commercial due rate according to § 353 HGB. A higher damage for delay may be enforced via a suitable verification.

5. Offers and Validity

All current price lists are generally valid until December 31 of the respective year, or until new price lists are published. The latest version of the price list will always be provided on our homepage. Offers older than 3 months at that point expire and must be replaced with new offers and prices.

6. Time of Delivery and Delay

We state the terms of delivery when accepting the order. The delivery date is non-binding and has mere guideline value - especially with regard to customised products. The terms for delay in delivery are defined by legal regulations. In any case, a writing notice issued by the purchaser is necessary for them to take effect.

7. Force Majeure (Act of God)

(1) SORG is not to be held responsible for the following delays of delivery. This also applies if these causes occur with respect to legal representatives, auxiliary persons, or deliverers of SORG: Circumstances of force majeure as well as other extraordinary events that are unpredictable and unavoidable for, and not caused by, SORG, and that only occur after ordering or reserving, and that SORG could not have known about. Moreover, this applies in case of strikes, fire, floods, labour disputes, business disruptions, altered magisterial approbation and legal situation, and magisterial orders which are not due to operational risks.
(2) In the cases of paragraph 1, SORG is eligible to delay delivery/performance for the time of hindrance as well as an appropriate start-up time. If SORG thus causes unacceptable complications for the purchaser, both SORG and the purchaser are eligible to withdraw from the contract. Circumstances that only lead to a temporal and hence acceptable delay of delivery and performance are excluded from this right. The legal rights of the client remain unaffected.

8. Dispatch

We generally dispatch uncovered by insurance and at the recipient's risk. We transfer the risk of accidental loss or deterioration of the goods as well as delay on to the client at the moment of passing the goods on to the forwarder, bearer, or any other person/institute responsible for delivery. SORG will make any effort to respect the client's wishes in terms of path and kind of delivery. Any costs caused by this (including agreed carriage free delivery) are to be covered by the client. In the case of carriage free delivery conducted by SORG, the recipient is required to put forward any carriage costs for a refund. If the client wishes the dispatch to be delayed, any risk of loss or deterioration of the goods is carried by the recipient from the first day of readiness for dispatch. The goods dispatched are only insured upon special demand and at the cost of the recipient.

9. Damage through Delivery

Upon delivery, the goods need to be checked for obvious damage in the presence of the bearer. Any damage is to be documented in a written form and co-signed by the bearer. This protocol is to be forwarded to us immediately. Delayed reclamations, or reclamations not signed by the bearer, cannot be taken into account.

10. Warranted Features, Receipt, and Technical Alterations

Delivered objects, even with minor damage, are to be accepted by the client, even if §433 paragraph 1 BGB is not fulfilled. Partial deliveries are permissible. Features only count as warranted if explicitly designated as such. A warranty of condition can only be asserted explicitly and in a written form. SORG reserves the right for technical alterations, especially for solutions of equal or higher value.

11. Warranty for Defects

(1) SORG warrants for any defects of delivered new goods for 12 months as long as the purchaser is not the user (§§ 474, 13 BGB). Should the purchaser be the user then the warranty period is two years for new goods, for used goods 12 months. Should the purchaser also be an entrepreneur, then the liability for used items is void, as long as there is no claim for compensation according to N° 12.
(2) The purchaser's claim for defects presuppose that he has attended his obligation to give notice of defects on the legal grounds for his reasons of inquiry (§§ 377, 381 HGB). If defects are found during the inspection or at a later point, we are to be notified in writing without delay. The notice counts as not delayed if issued within two weeks. Posting the notice on time suffices for the keeping of the term. Independently from this obligation to inspect and give notice, the purchaser is to report obvious defects (including wrong and short delivery) within two weeks upon delivery (again, posting the notice on time suffices). If the purchaser misses the proper inspection and/or notice of defects, we do not warrant for the reported defects. If the delivered good is defected, we may choose to conduct supplementary performance either by repairing the defect (subsequent improvement) or by delivering flawless goods (compensation delivery). Our right to refuse the chosen method of supplementary performance on the respective legal grounds remains untouched.

(3) Our liability for defects expires when alteration or maintenance works are done by the client or a third-person-party without our prior written permission. Consequences of excessive strain, negligent or incorrect handling, and violent damage are excluded from the warranty for defects.
(4) Liability for defects is excluded if these are wearing parts. Included here for example are damper elements, textile parts, wheels and brake parts.
(5) Additional regulations can be found in our service booklet or instructions for use.

12. Further Liability

(1) With respect to compensation - regardless of the legal cause - SORG is only liable in case of malice and act of gross negligence. In case of slight negligence, SORG is only liable for damage of life, body, health, and for damage caused by the negligence of an essential contractual obligation (an obligation whose fulfillment make the proper realisation of the contract possible in the first place and in whose fulfillment the contract partner regularly trusts and can trust). In this case, however, our liability does not exceed the covering of predictable, typically occurring damage.
(2) A free right to termination on the part of the purchaser (acc. to § 651, 649 BGB in particular) is precluded. Otherwise, the usual prerequisites and legal consequences apply.

13. Costs of Supplementary Performance

Costs of supplementary performance cannot be charged on SORG's account.

14. Voluntary Withdrawal of Goods

SORG is not obliged to take back any delivered end products or parts thereof. If SORG voluntarily decides otherwise in individual cases (especially for therapeutically altered requirements or deaths), SORG refunds a maximum of 75% of the delivery costs for unused parts whose delivery does not date back more than three months. There is no legal obligation concerning withdrawal in this respect. Deliveries which date back more than three months as well as sewed parts and customised products are not returnable. A copy of the delivery note or the bill serves as proof of age of delivery.

15. Reservation of Ownership

Goods delivered by SORG remain the property of SORG until any obligations from the parties' business contract on the part of the purchaser have been redeemed. This also applies if SORG has adapted individual or all claims into a running account which has been balanced and acknowledged. The purchaser has the right to dispose of the goods in the proper course of business. The purchaser hereby yields all claims to SORG which arise from the resale against the purchaser or third parties. The purchaser is authorised to withdraw these claims even upon conveyance. SORG's right to withdraw the claims remains untouched. However, SORG is obliged not to withdraw the claims as long as the purchaser complies with his duty of payment and any other duties. SORG has the right to demand that the purchaser makes known the yielded claims and their debtors, that he provides all information necessary for conveyance, and that he hands in all associated documents. As long and insofar the reservation of ownership is intact, the purchaser must not transfer any goods for securing or bailment without SORG's permission. The purchaser may process or alter the goods for the benefit of SORG exclusively. If processed with other goods which do not belong to SORG, SORG obtains co-ownership of these new goods in relation to the invoice value to the cost price of the other processed goods. If a third party interferes with SORG's ownership, the purchaser is to notify SORG immediately. The purchaser must not make any agreements with other purchasers which may exclude or limit SORG's rights. In particular, the purchaser must not make any agreements which destroy or limit the advance assignments to SORG. If the estimated value of the existing guarantees exceeds the claims to be ensured by more than 20%, SORG is insofar obliged to release by request of the purchaser.

16. Copyright Protection

If SORG conveys any images, drawings, indications of weight or measurements, technical documentations, or other product descriptions and documents (including electronic ones), the respective indications only apply if explicitly stated that they do. SORG reserves ownership and copyright of all these documents. They may only be made available to third parties upon SORG's explicit permission.

17. Place of Fulfilment, Place of Jurisdiction, and Severability Clause

(1) The law of the Federal Republic of Germany applies for these Terms and Conditions and all legal relations between us and our business partners. All international and supranational (contractual) legal systems, the UN Convention on Contracts for the International Sale of Goods in particular, are hereby excluded. Prerequisites and effects of the reservation of ownership acc. to no. 15 are subject to the right of the respective storage location of the good if the choice of law made in favour of the German law is illegitimate or ineffective. The only place of jurisdiction (also on an international basis) for any disputes arising directly or indirectly from the contractual relationship is, according to German Commercial Code, our office in Oberhausen-Rheinhausen, Germany. However, we also have the right to file a suit concerning the general jurisdiction of the purchaser.
(2) If any clause in these Terms of Conditions should turn out to be ineffective, this does not affect the effectiveness of all other clauses.

Technical alterations and misprints reserved. As of: October 2024
SORG Rollstuhltechnik GmbH + Co. KG
Benzstr. 3-5, 68794 Oberhausen-Rheinhausen / Germany
Phone +49 7254 / 9279-0
Fax +49 7254 / 9279-10
info@sorgrollstuhltechnik.de, www.sorgrollstuhltechnik.de