

Mio Carbon Design 2018



Instructions for use

Imprint

SORG Rollstuhltechnik GmbH+Co.KG
Benzstraße 3-5
68794 Oberhausen-Rheinhausen / Germany

Tel. +49 7254-9279-0
Fax +49 7254-9279-10
E-Mail info@sorgrollstuhltechnik.de
Web www.sorgrollstuhltechnik.de

Revision status

2024-10-15

Technical status

Technical changes and misprints reserved. The pictures in this Instructions for use can differ from the actual equipment components. However, a corresponding conduction is possible.

Copyright

All texts, pictures and graphics underlie copyright protection. All rights, including copying, publishing, editing and translating, remain reserved. © by SORG Rollstuhltechnik GmbH+Co. KG Benzstraße 3-5, 68794 Oberhausen-Rheinhausen / Germany.

 Our terms and conditions can be found on our order forms and at www.sorgrollstuhltechnik.de/impressum.

1 Wheelchair overview	4	4 Repair/maintenance/reinstatement	26
2 General Information	5	4.1 Repairs	26
2.1 Preamble	5	4.2 Spare parts	26
2.2 General use indications	5	4.3 Maintenance	26
2.2.1 Signs and Symbols	6	4.4 Disinfection	26
2.2.2 Intensions	7	4.5 Storage	26
2.2.3 Indication	7	4.6 Lifespan	27
2.2.4 Counterindication	7	4.7 Reinstatement	27
2.3 General safety instructions	8	4.8 Disposal	27
2.3.1 Transporting without use	10	4.9 Maintenance/Inspection	27
2.3.2 Other important indications	10	5 Technical data	29
3 Handling	12	5.1 Data and measurements	29
3.1 Handling rear wheels	12	5.2 Meaning of labels	30
3.1.1 General Indications	12	5.3 Declaration of conformity	30
3.1.2 Tire pressure	12	5.4 Guarantee	30
3.1.3 Axle wheels	12	6 Verification of yearly inspection	31
3.1.4 Double hand rim wheels	13		
3.2 Handling casters	14		
3.2.1 General indications	14		
3.2.2 caster track lock on a taurus frame	14		
3.3 Handling push aids	15		
3.3.1 General indications	15		
3.3.2 push handles	16		
3.3.3 push bail	17		
3.4 Handling leg support	17		
3.4.1 General indications	17		
3.5 Handling brake	18		
3.5.1 General indications	18		
3.5.2 Bowden cable brake	18		
3.5 Handling brake	19		
3.5.3 drum brake	20		
3.6 Handling anti-tipper	21		
3.6.1 General indications	21		
3.7 Handling head rest	22		
3.7.1 General indications	22		
3.8 Handling abduction wedge	23		
3.8.1 Allgemeine Hinweise Abduktionskeil	23		
3.9 Handling side truss pads	23		
3.9.1 General indications	23		
3.10 Handling outdoor-front-end	24		
3.10.1 General indications	24		
3.11 Handling sun shade	25		
3.11.1 General indications	25		

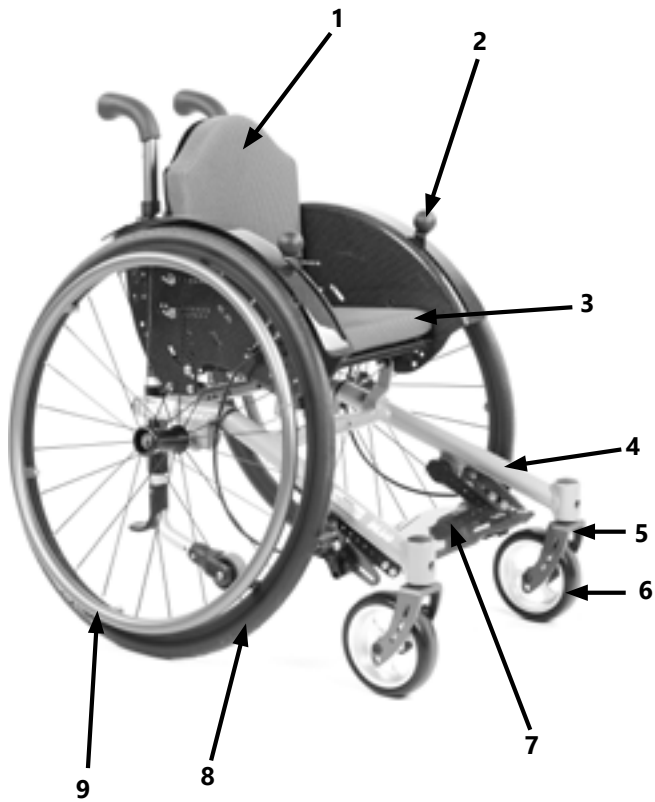

- 1 back cushion
- 2 brake lever (for Bowden cable brake)
- 3 seat cushion
- 4 frame
- 5 caster fork
- 6 caster
- 7 foot plate
- 8 rear wheel
- 9 hand rim

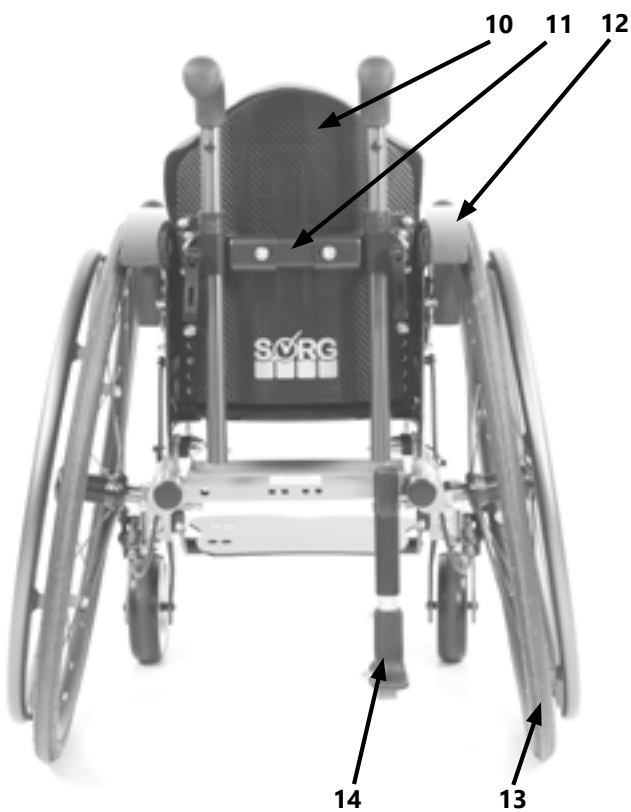

- 10 back
- 11 stabiliser bar
- 12 side guard
- 13 rear wheel
- 14 anti-tipper

2.1 Preamble

Welcome to the SORG family - thank you for your trust in us and for choosing our product.

This wheelchair has been individually made to measure your particular needs.



In order to be able to use the wheelchair in everyday life, you receive the following usage and setting instructions which can be done without tools. Please take note of these instructions and handle the wheelchair carefully so that it gives you pleasure for a long time.

If you have any questions about this or any other product, please contact us.

We hope you enjoy using your SORG product.

Your SORG-Team

2.2 General use indications

This Instructions for use contains safety instructions which are needed for the proper use of our product.

All adjustments, repairs and annual inspections beyond these instructions must be carried out by a qualified specialist retailer.

Before use, the user and rehab technician must have read and understood these instructions. In this Instructions for use you will find all equipment possibilities of the product. Have yourself be instructed on the safe handling of the wheelchair, on an even surface, and its individual equipment possibilities by your specialist adviser.

 Visually impaired people will find this manual as a PDF and audio file on our website www.sorgrollstuhltechnik.de.

Should questions or suggestions come up then please contact your medical supply store or our team (+49 7254 9279-0).

Keep this manual in a safe place. All yearly inspections done must be documented by your specialist retailer. .

2 General Information

2.2.1 Signs and Symbols



ATTENTION! Warnings for personal Safety aspects that are of the utmost importance.



CORRECT safety adjustment/ use



WRONG adjustment/ use



NOT ALLOWED



References to additional/continuing reading.



important detail



correct or proper use/setting



incorrect or improper use/setting

(A); (B)

reference from text to detail

Use



push/ pull/ insert / move/



push in specific direction



Setting or adjusting the angle



open/ close



Turn clockwise



Turn counter-clockwise



steps to be done at the same time



steps to be done after each other



steps to be done on both sides



point of view



view from top

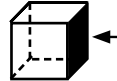

view from the side



view from the bottom



view from the front



view from the back



fasten parts



remove parts

2.2.2 Intensions

Mio Carbon (Design 2018) is a light active-wheelchair for children and adults for indoors and outdoors.

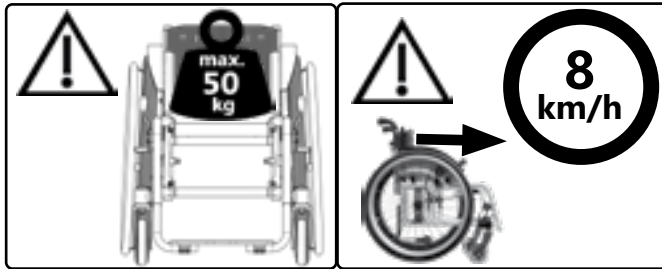

The wheelchair only serves to carry the person for whom it has been adapted, by a qualified specialist retailer.

In the case of children or persons with impaired ability to act, the parents or authorized caregivers must ensure that the instructions in the Instructions for use are followed.

The most secure use of the tool is only possible on a level, firm and dry ground with activated anti-tipper with the help of a caregiver.

⚠ Any further use involves many dangers that can only be assumed on the user's own responsibility. This requires sufficient competence of hazard detection and prevention and safe handling of the user with the aid! Increased risk potential must be taken into account especially in wet conditions, ice, loose ground, inclines, obstacles, proximity to water, road traffic, tight spaces, etc.

⚠ Use the wheelchair only according to its purpose. Any improper use entails significant risks and will void the product liability.

⚠ Due to the great variety of combinations for seat and wheel positions, settings can be possible which are outside of the safety and application area.

2.2.3 Indication

The use is suitable for the following functional impairments:

- all forms of neuromuscular sicknesses
- all forms of side dominance/paresis,
- all forms of skeletal deformities,
- limited or missing head control,
- brittle bone disease,
- Spina Bifida,
- posttraumatic and/or postoperative reactivation.

2.2.4 Counterindication

The use is not suitable with:

- tonicity deregulation,
- high disturbances of equilibrium,
- limb loss on both arms
- joint contractures/joint damages on both arms,
- unable to sit,
- not enough eyesight

⚠ We cannot be taken accountable for damages done to people or objects originating from the use of the Mio under the conditions described above.

2 General Information

2.3 General safety instructions

- Before each use be sure to check:
- frame, back tubes, attachments and accessories for visible damage, bends, cracks or missing/loose screws,
 - wheels/quick release axles for firm fit ,
 - sufficient tire pressure, tire tread,
 - functionality of the brakes,
 - firm fit of the angle adjustment elements/ eccentric clamps,
 - firm fit of the seat plate/ the back/ the foot plate,
 - functionality of the anti-tipper/ seat and back straps,
 - if all previously disassembled parts are re-inserted or firmly locked.

There is a risk of injuries (e. g. such as bruising) on all rotating or folding parts, including adjustments, repairs and transport.

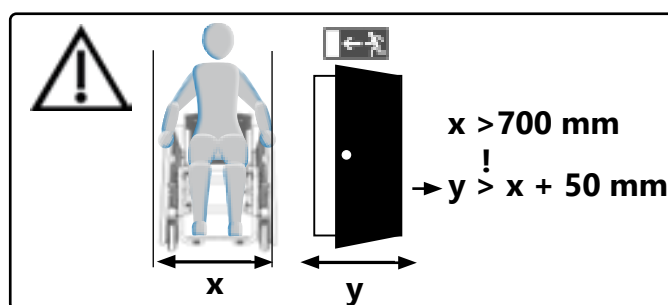
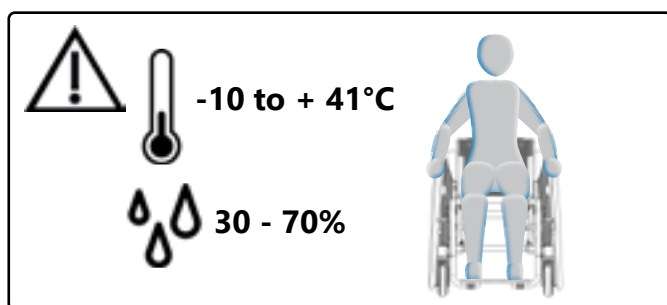

danger of tipping and flipping over

Getting in and out can only occur on a flat surface and with activated wheel lock.

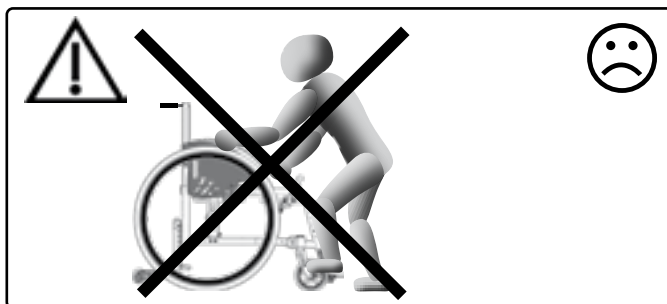

Do not use the footplate(s) to get in and out. The wheelchair could tip forward.

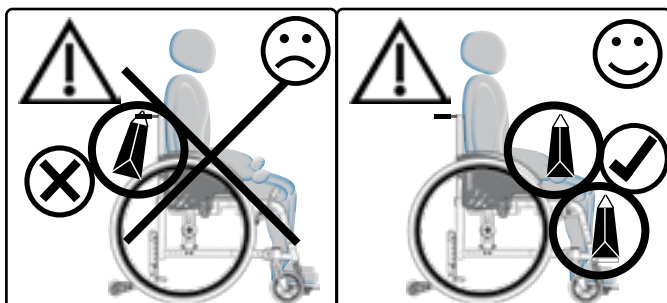

When dismantling the parts/accessories listed below, the risks listed as examples may occur:

- cushion: lack of hygiene/pressure points
- head rests: Loss or missing head rest during transport
- firm back extension: Loss or missing head support during transport
- rear wheels: loss of wheels - use is no longer possible

2 General Information

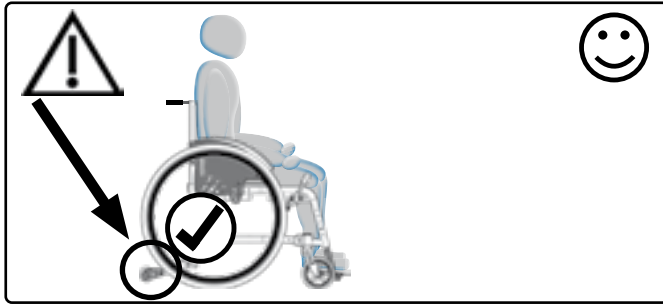

⚠ We generally recommend the use of the anti-tipper.

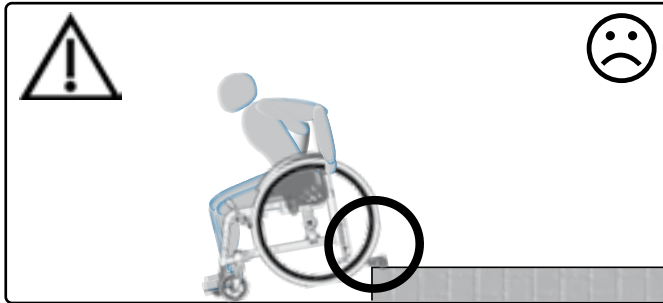

⚠ When driving off of curbsides the anti-tipper must be deactivated.

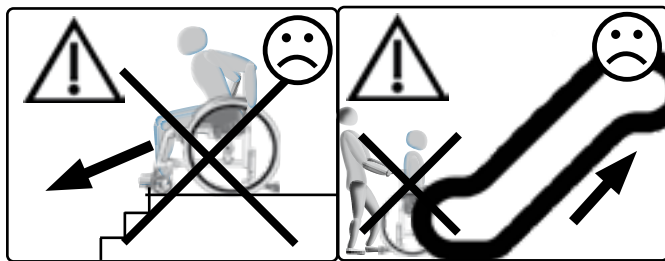
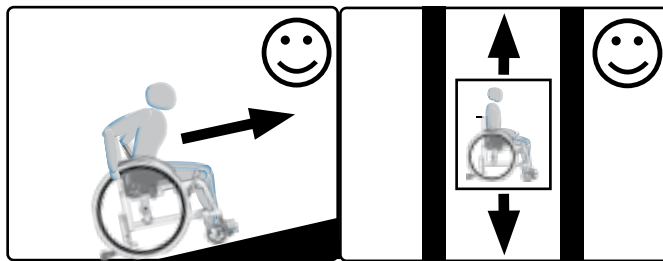

⚠ Overcome stairs only with the help of experienced helpers. For this, the anti-tipper must be deactivated. Only carry the wheelchair **by holding the frame, never** the seat shell, the push handles/push bail, the leg support and/or the foot plate/s!

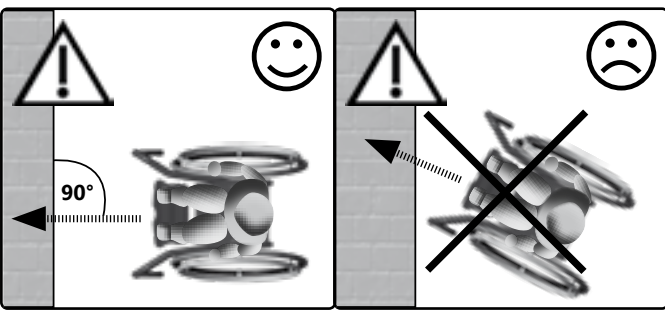
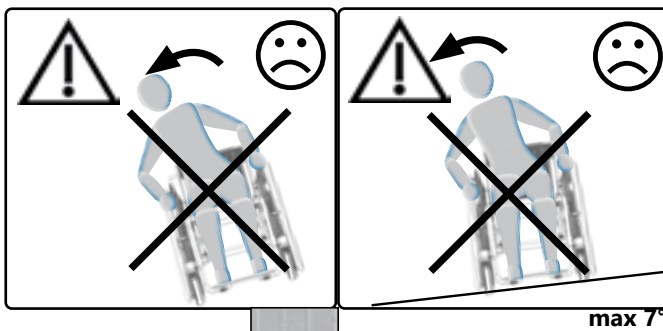

inclines, downhill and obstacles

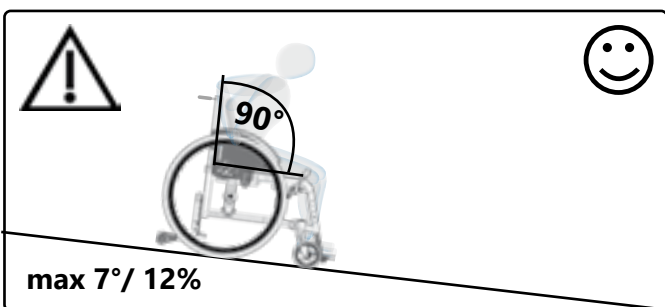
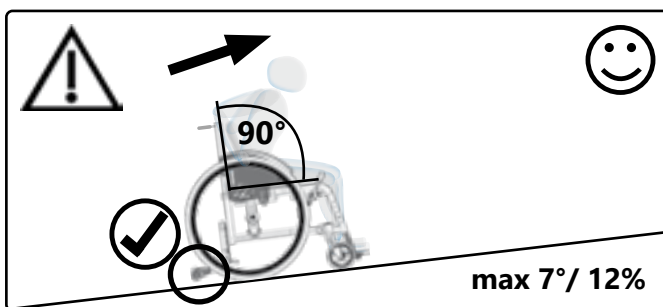

2.3.1 Transporting without use

Make the desired packing size and secure the wheelchair and all disassembled parts with adequate load securing. Before transporting a wheelchair, find out about suitable load securing measures.

Carrying points:

- seat tubes in a folded position
- front frame tubes le/ri
- back frame tubes le/ri
- however **not** on the detachable leg supports and/or foot plates.

2.3.2 Other important indications

 The Mio Carbon (Design 2018) is **not** zugelassen als Sitz für den Transport in Kraftfahrzeugen.

 The standard-compliant resistance to inflammation of textile materials was tested and ensured. Nevertheless there is a risk of ignition of the flammable textile components. Keep ignition sources away from the wheelchair.

 The wheelchair must not be exposed to excessive moisture or contact with salt water.

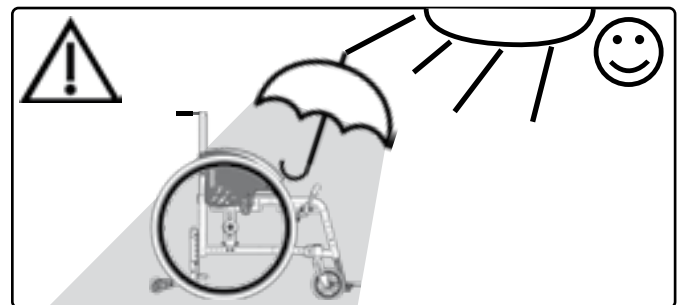
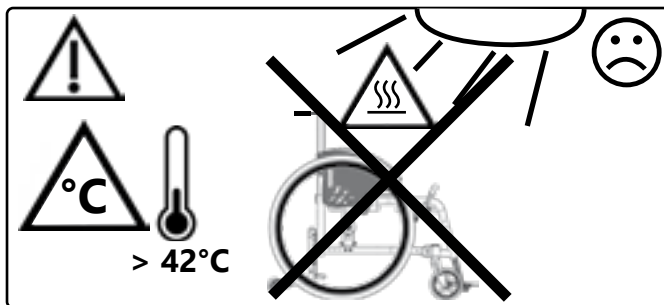

Pelvic restraints (pelvice belts as positioning help) can be ordered as an option in the wheelchair configuration via the SORG order forms or by ordering via spare parts catalogues. The assembly is carried out by your retailer.

In some cases, the product may interact with electromagnetic fields (e.g., anti-theft device in stores). There is no danger for the user and/or the companion.

Due to the wide range of settings, it is not possible to comply with all limit values for all possible configurations under the EU Interoperability Technical Regulations with regard to the accessibility of the Union rail system for persons with disabilities and persons with reduced mobility.

In the case of incidents involving the wheelchair, please contact your specialized retailer or us as manufacturer. Product recalls etc. are published on our website www.sorgrollstuhltechnik.de. There you will also find the respective contact persons.

Corrosion protection

The product is already designed for corrosion protection when selecting materials (for example: plastic, aluminum, stainless steel). All materials susceptible to corrosion are surface-treated and thus protected.

Should the wheelchair get wet, it needs to thoroughly dry.

Lifespan

 Use beyond the specified lifespan increases the residual risks and should only be carried out after careful, qualified consideration by the operator. If the useful life is reached, the user or a responsible person should contact the specialist dealer. There you can be informed about the possibility of reprocessing the product.

Combination with products from other manufacturers

 The wheelchair may only be combined with the electrical auxiliary drives approved by the manufacturer. The responsibility of restrictions or adjustments as well as the attachment itself lies with the supplier of the additional system or the specialized retailer. Please ask about the conditions with the manufacturer of the auxiliary drives.

 In combination of wheelchair and electric auxiliary drive, certain strains occur that can lead to damage to the wheelchair. Slowly approach obstacles and carefully overcome them so that little force is applied to the casters, rear wheels and the wheelchair as a whole.

3.1 Handling rear wheels

3.1.1 General Indications

By braking the wheels with the hand rims, friction heat occurs.

Hand rim covers can expand from heat and can come off the hand rims.

3.1.2 Tire pressure

The appropriate operating pressure can be found on the tire casing - usually 3-10 bar. **(1)**

When you get a flat tire, please contact your retailer.



3.1.3 Axle wheels

Remove:

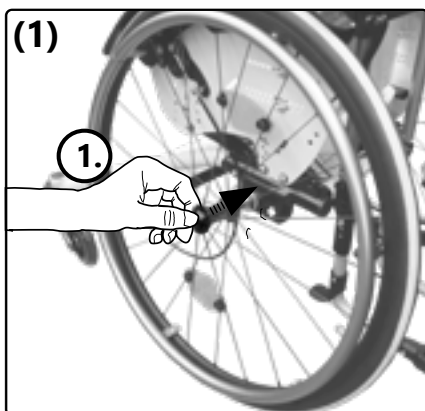

+

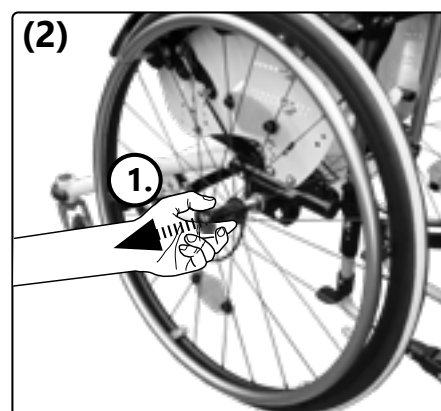

Put on:

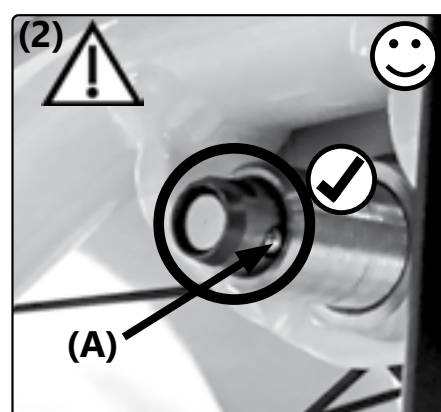
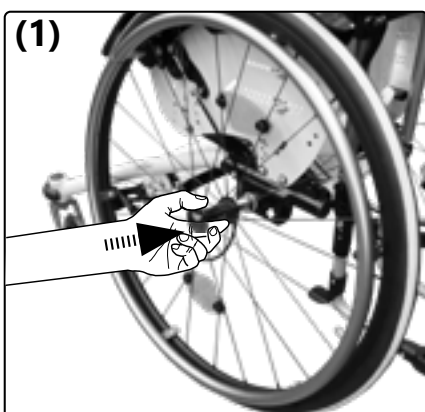

(2) After inserting, the locking ball **(A)** must protrude visibly. After each insertion, pull at least 1x to test whether the quick release axle is engaged. The wheels should not be able to pull out.

3.1 Handling rear wheels

3.1.4 Double hand rim wheels

Put on:

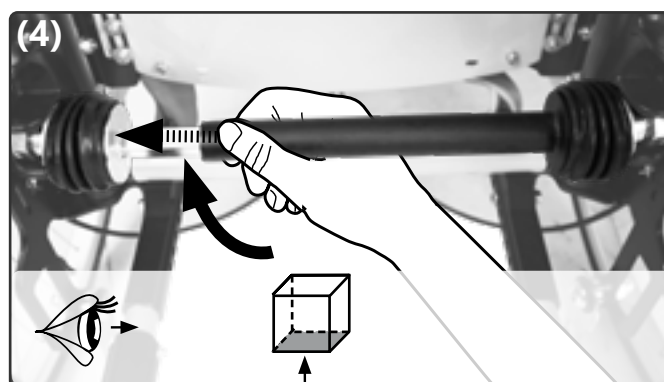
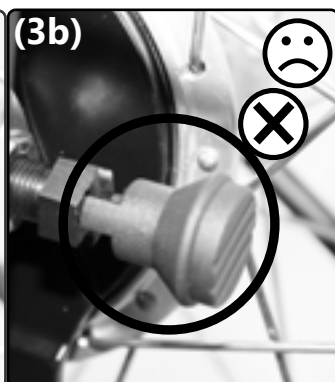
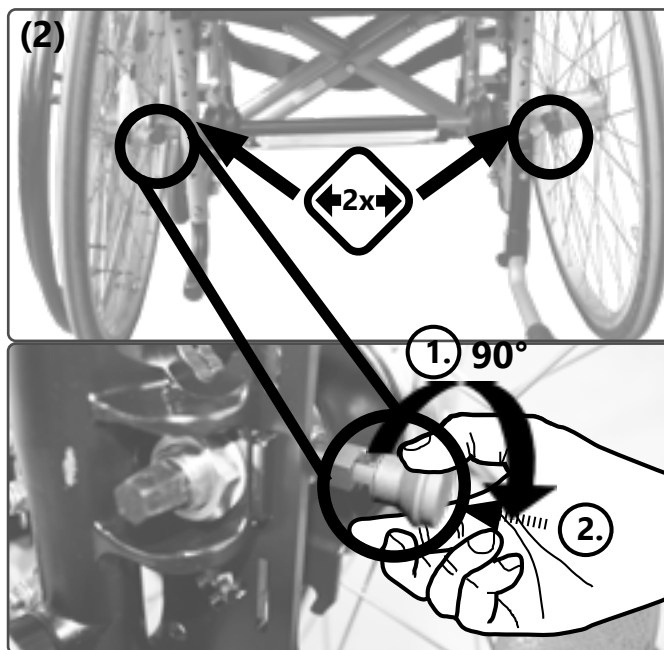
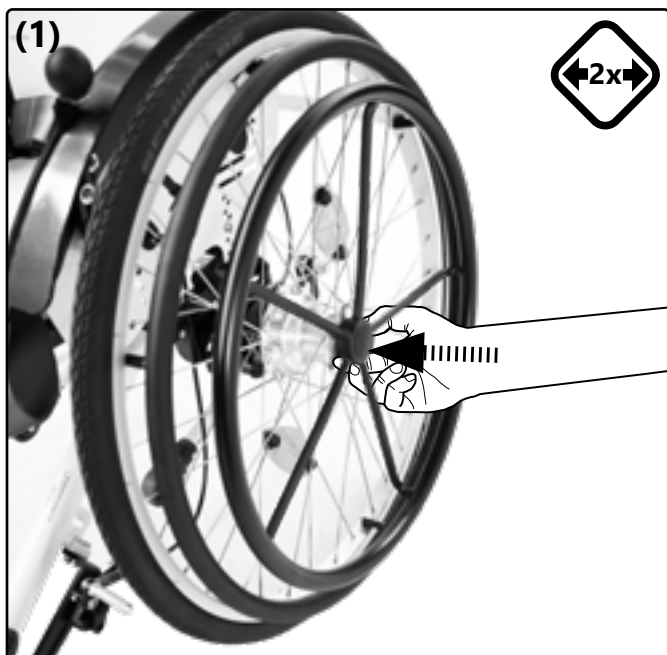

Remove: Proceed analogously in reverse order

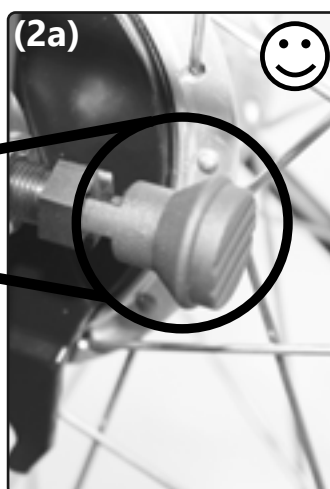

3.2 Handling casters

3.2.1 General indications

Incorrectly adjusted casters or driving too fast can cause the casters to flutter. At the first sign of flutter, slow down the drive immediately and have the casters readjusted by a specialist retailer.

3.2.2 caster track lock on a taurus frame

unlock:

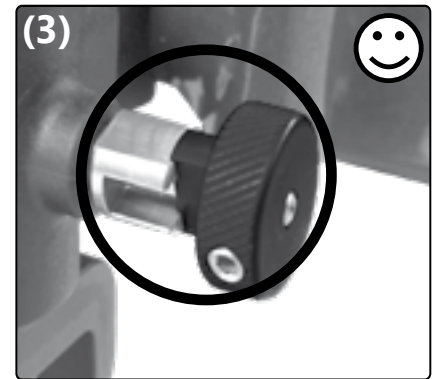
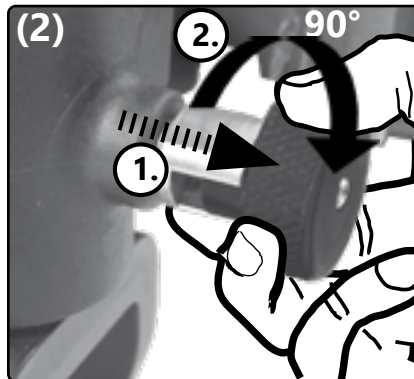
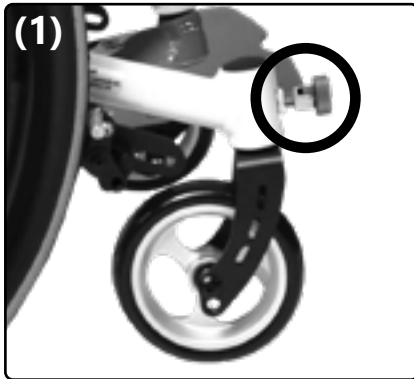

lock:

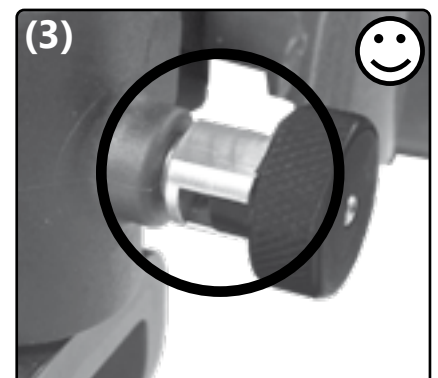
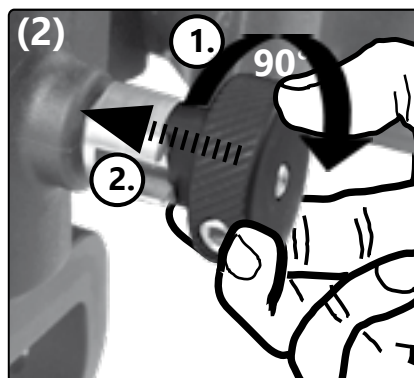
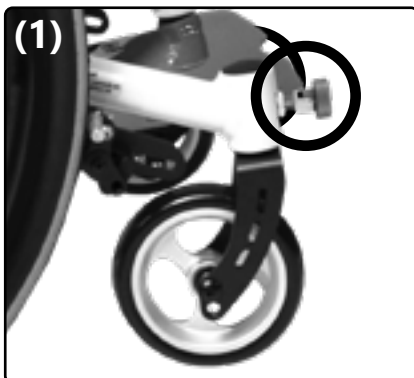

3.3 Handling push aids

3.3.1 General indications

All height adjustable push aids are designed exclusively to push the occupant in their wheelchair - **not to carry**.

Children cannot assess the pivoting range of the push aids and can hurt others while playing. It is recommended to fold in or remove the push aids for such purposes.

Before each use of the push aids, check that the eccentric clamps are tightly closed and function properly. The push aids must not be able to move in the closed position of the eccentric clamps.

setting the eccentric clamps:

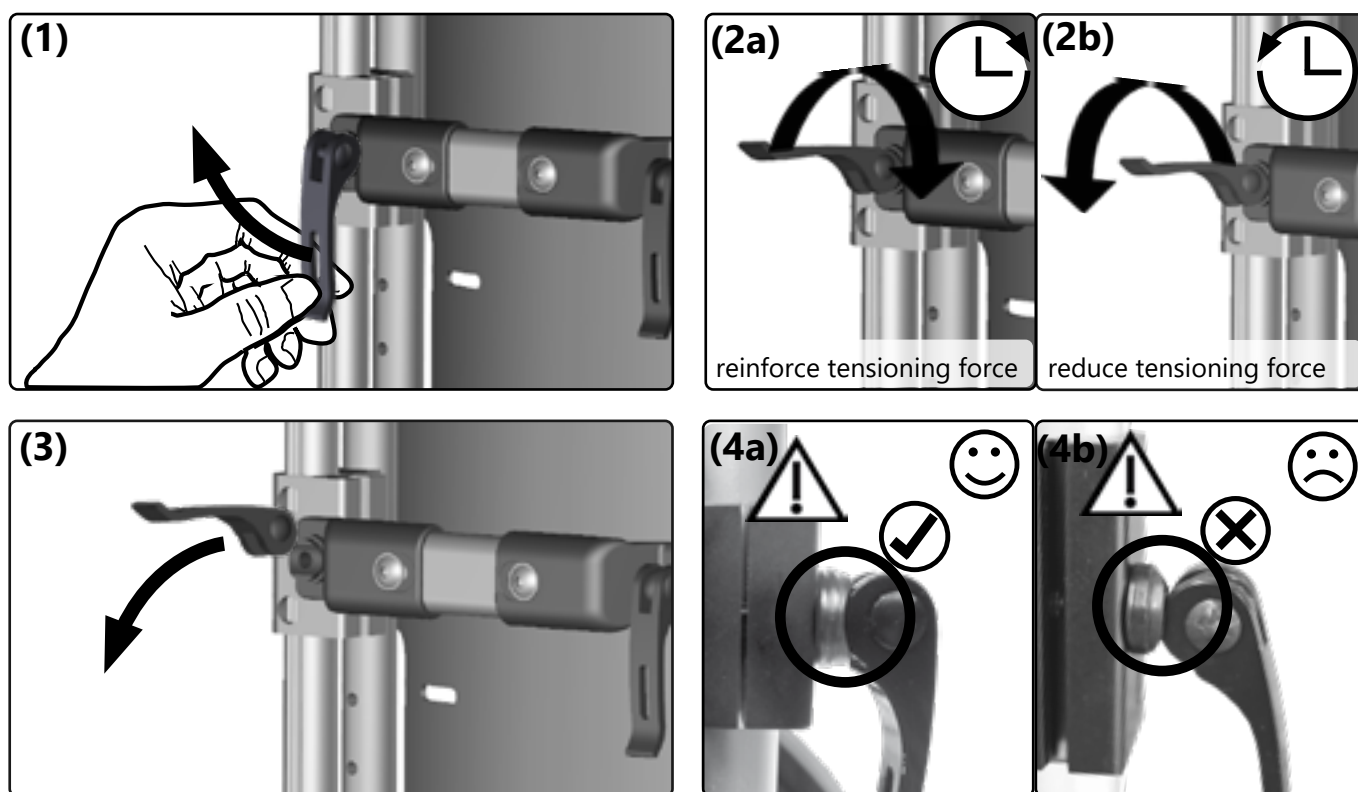

3.3 Handling push aids

3.3.2 push handles

adjusting the height:

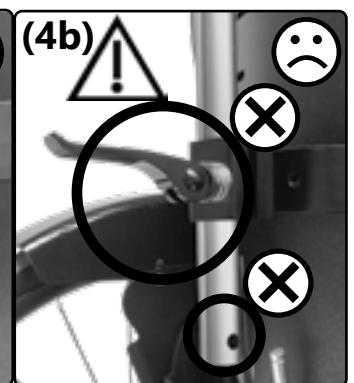
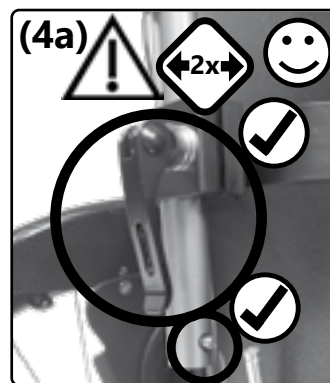
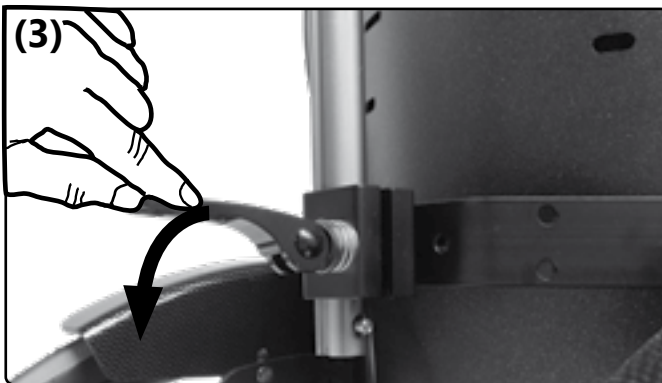
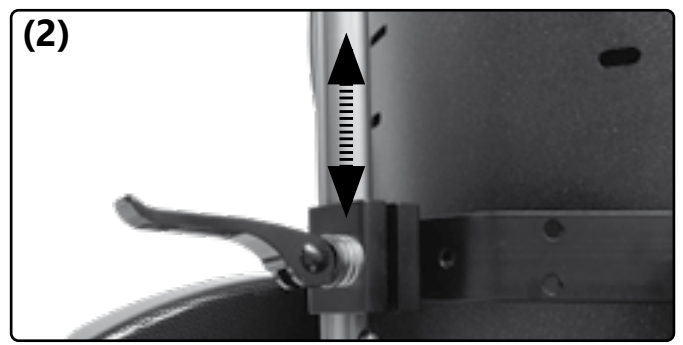
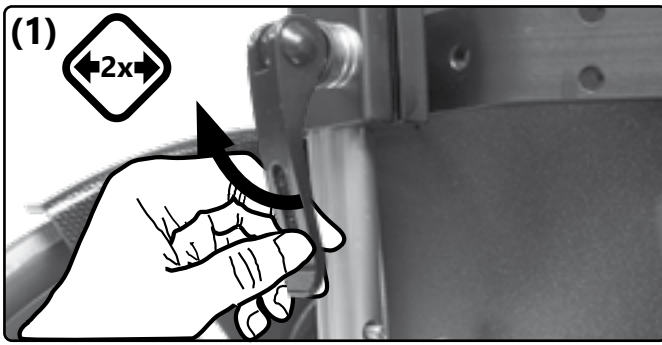

putting on (remove: proceed analogously in reverse order):

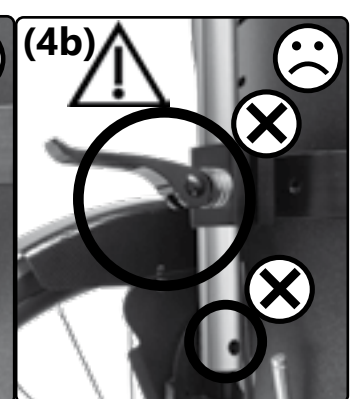
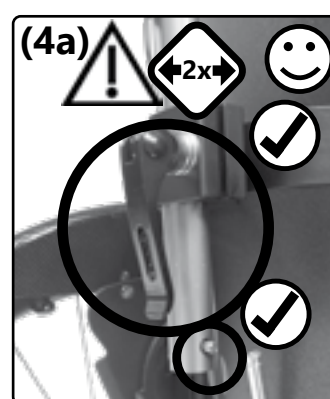
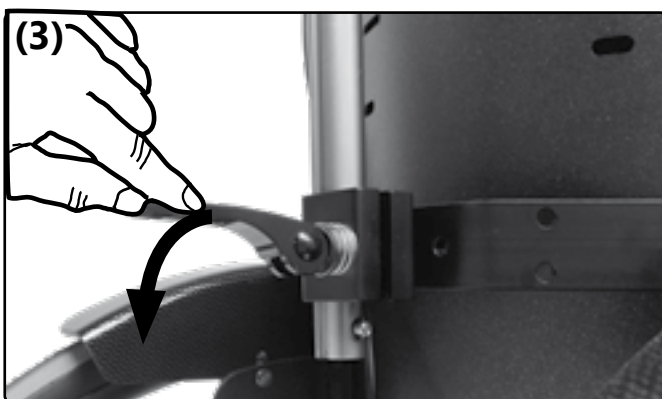
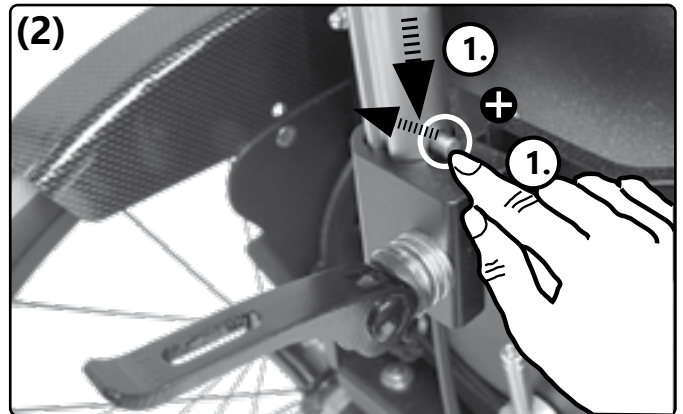
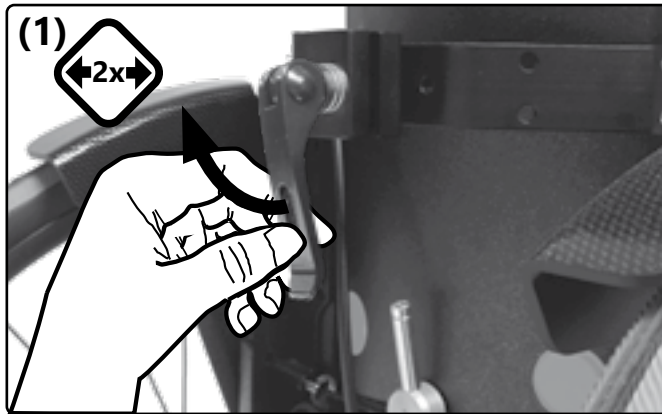

3.3 Handling push aids

3.3.3 push bail

adjusting the angle:

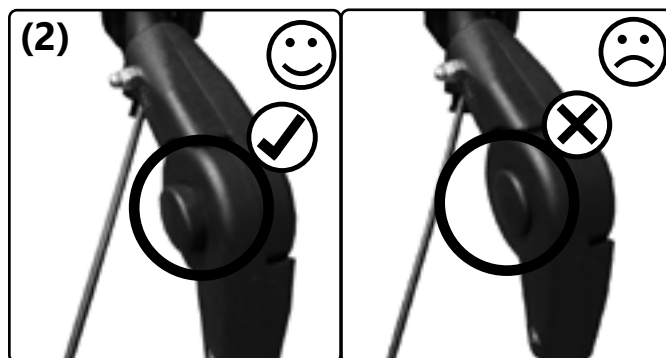
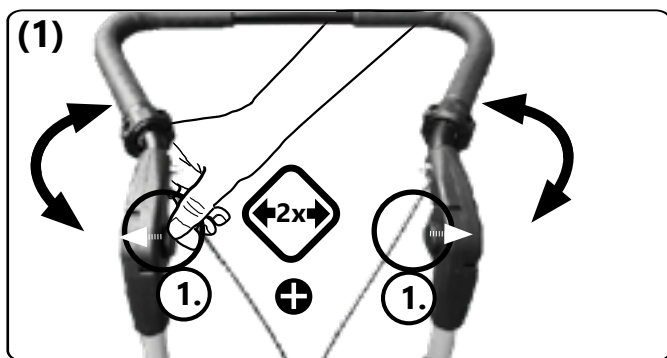

3.4 Handling leg support

3.4.1 General indications

Types of leg supports and their handling:

Model 1:



All adjustments must be made a specialist retailer.

3.5 Handling brake

3.5.1 General indications

Check the functionality of the brakes before each use! If the braking effect wears off, contact your retailer immediately.

Possible impairments or malfunctions can be caused by:

- dirty or incorrectly adjusted brakes,
- defective cables,
- too great distance between the brake pressure pin and the tire,
- too low tire pressure (information on the tire casing),
- wetness, snow, mud, etc.,
- worn tread,
- worn or dirty brake pressure bolts.

The wheelchair is not ready for use until all malfunctions of the brakes have been corrected.

Always check the functionality and secure lock of the brakes on slopes.

3.5.2 Bowden cable brake

lock:

The Bowden cable brake is a locking brake and **not** suitable for braking while driving.

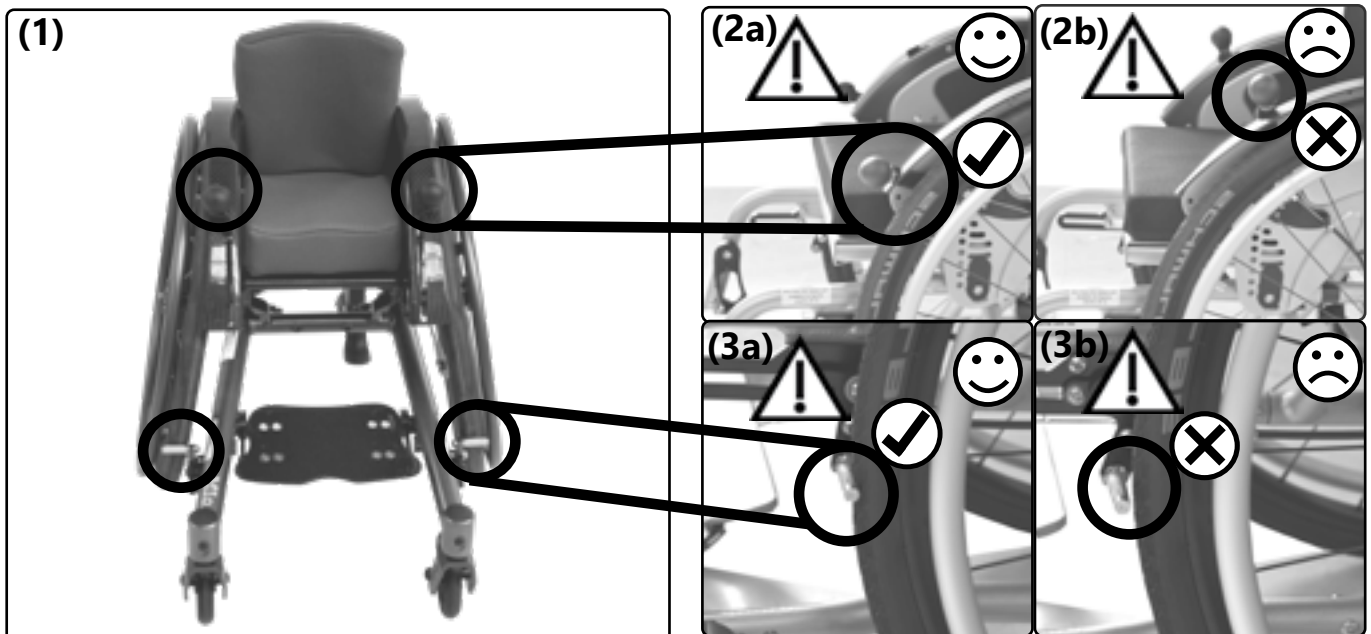

3.5 Handling brake

lock:

The use of the lock can lead to dangerous situations. An instructed attendant must supervise at all times.

First, put the Bowden cable brake in the wanted position (locked/ unlocked) and fixate this as follows:

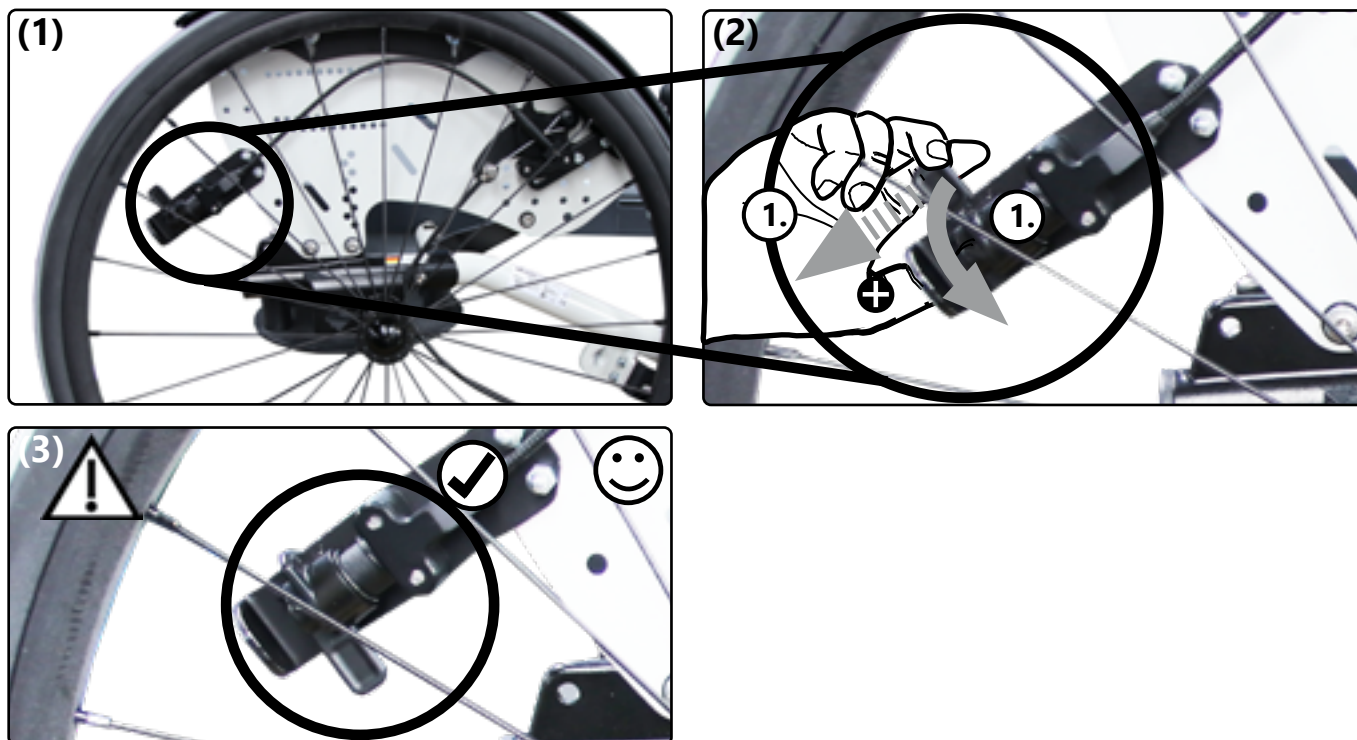

unlock:

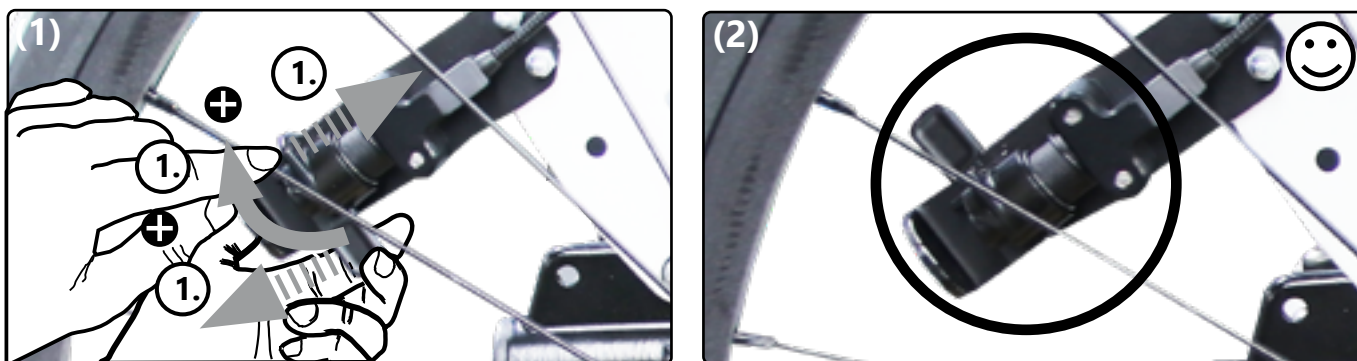

3.5 Handlingbrake

3.5.3 drum brake

brake:

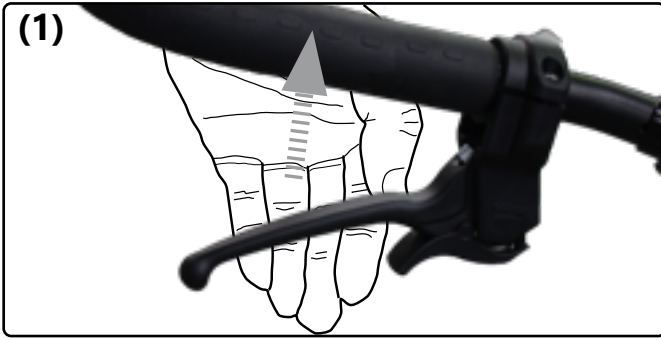

⚠ Uneven use of both brake levers creates cornering

⚠ Clean the brake block of the drum brake wheels in short intervals with a soft brush.

tighten:

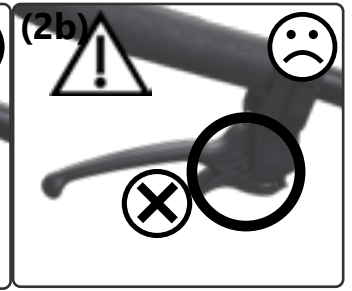
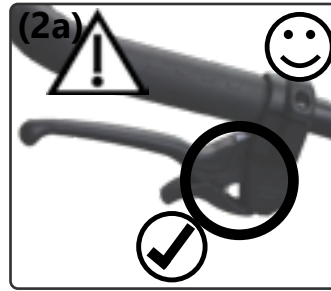
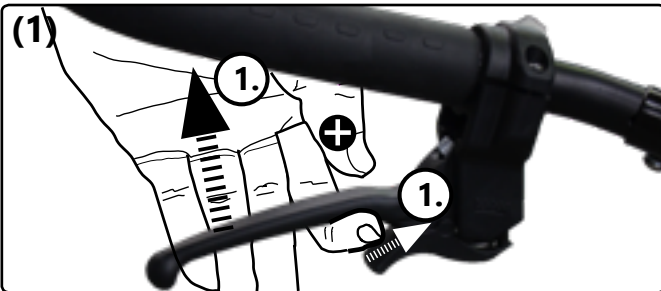

loosen:

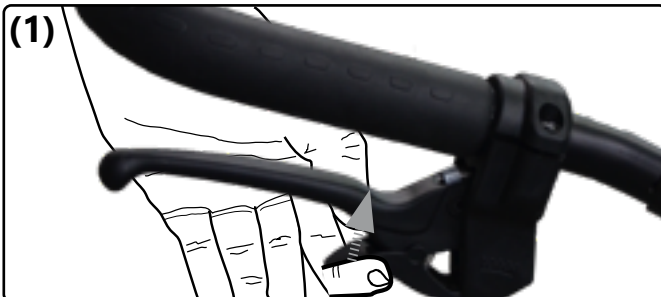

3.6 Handling anti-tipper

3.6.1 General indications

In the case of leg amputations, a wheel base extension, or at least an anti-tipper should be used to improve the tipping stability.

A wheel base extension is **not** a replacement for an anti-tipper.

activate:

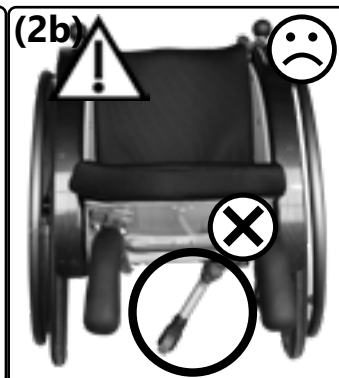
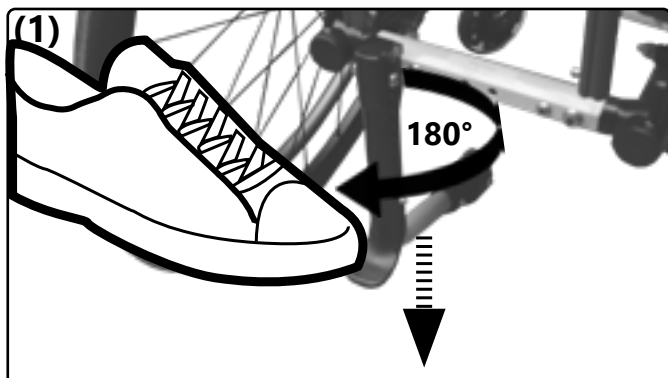

The anti-tipper must always snap back into place when in its final position.

deactivate:

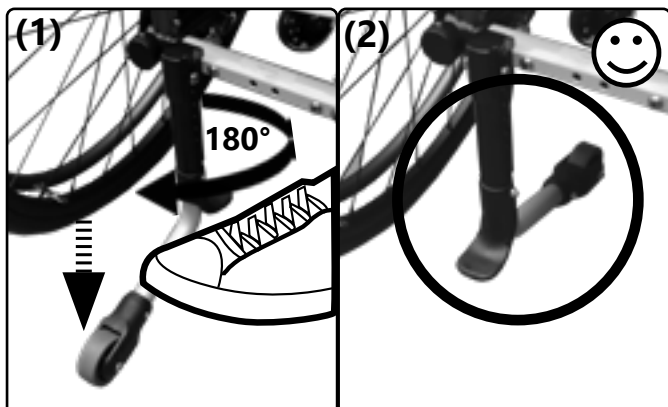

Always turn the anti-tipper only 180° from the deactivated position to the active position. Avoid fully turning in one direction, otherwise the tension spring inside the anti-tipper will be damaged and the anti-tipper may lose its functionality.

3.7 Handling head rest

3.7.1 General indications

setting the distance:

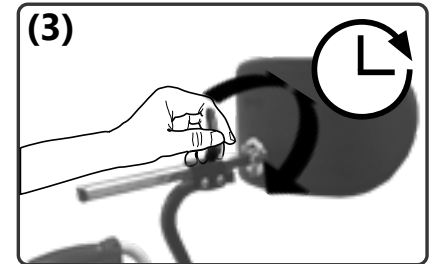
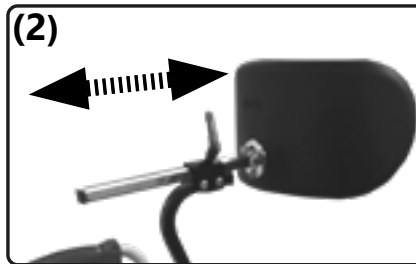
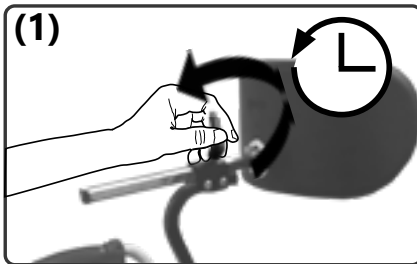
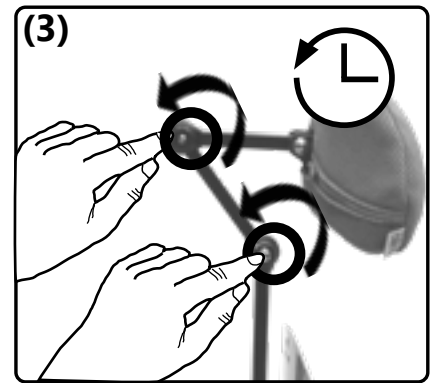
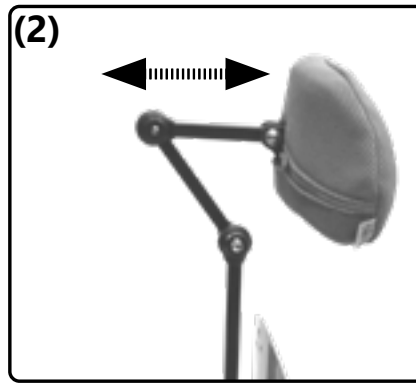
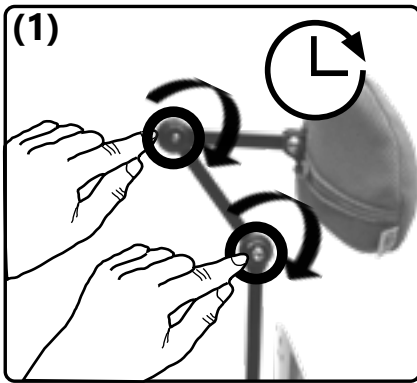

setting the height:

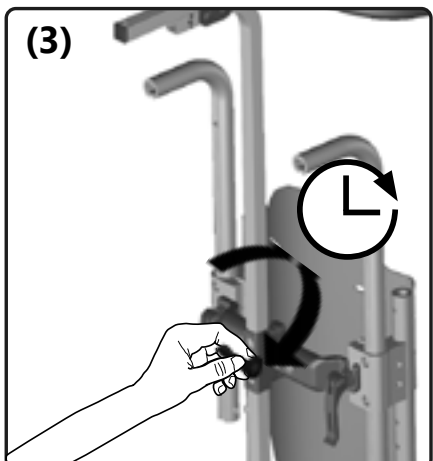
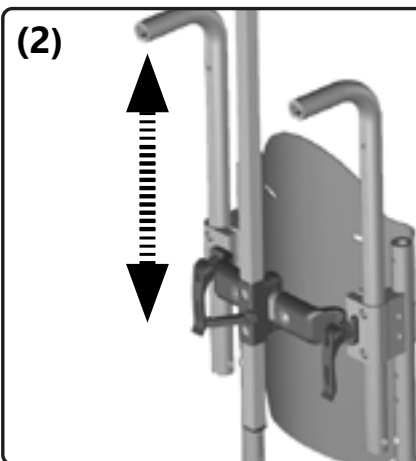
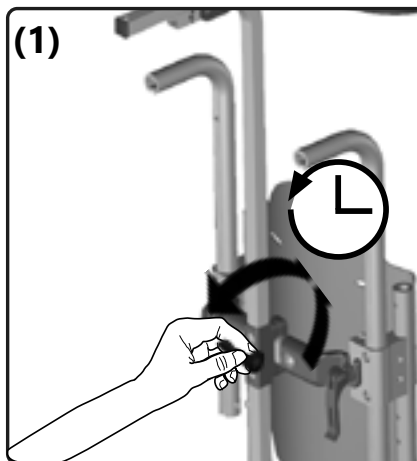
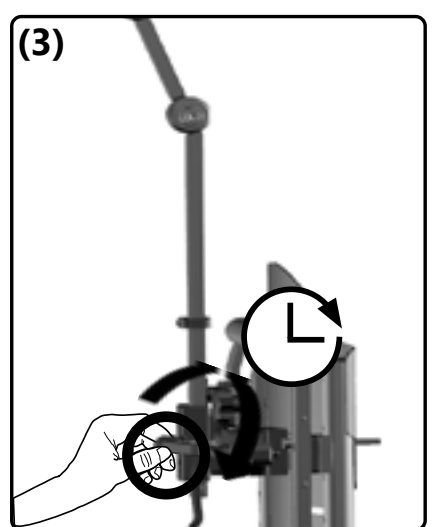
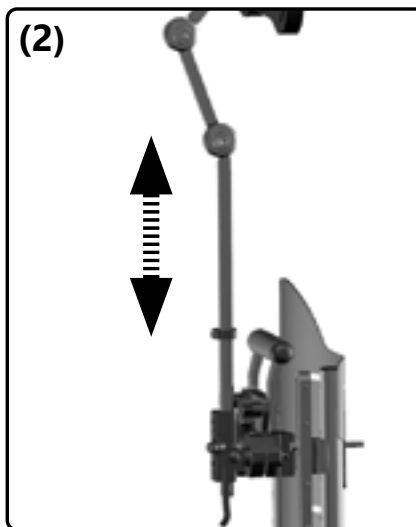
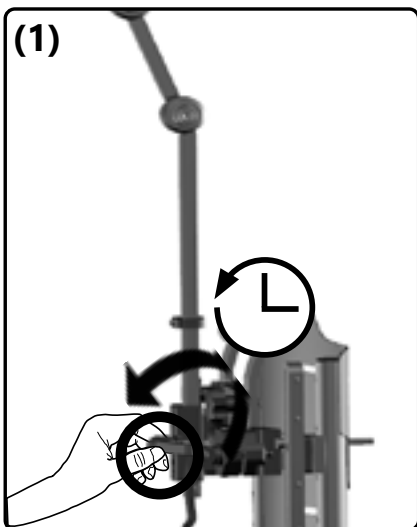

3.8 Handling abduction wedge

3.8.1 Allgemeine Hinweise Abduktionskeil

setting the distance:

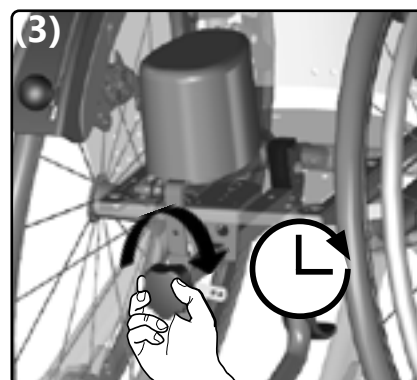
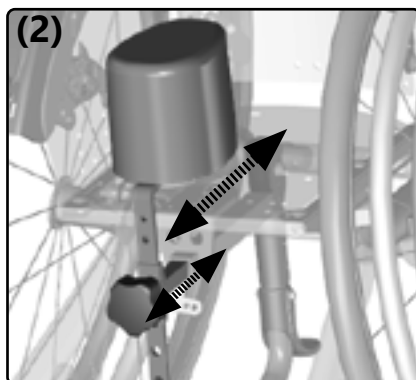
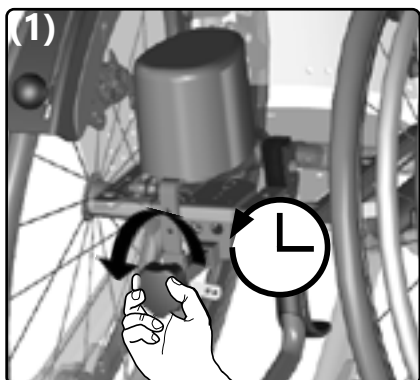

setting the height:

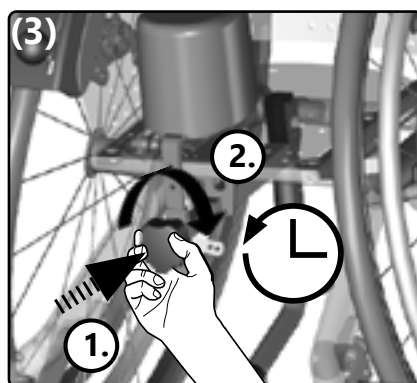
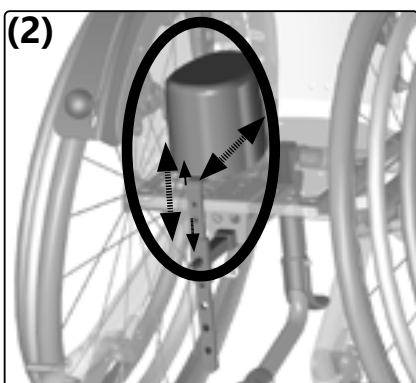
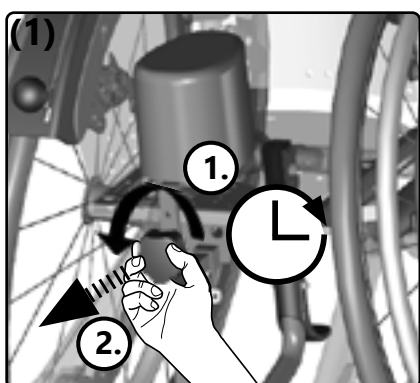

3.9 Handling side truss pads

3.9.1 General indications

open/close:

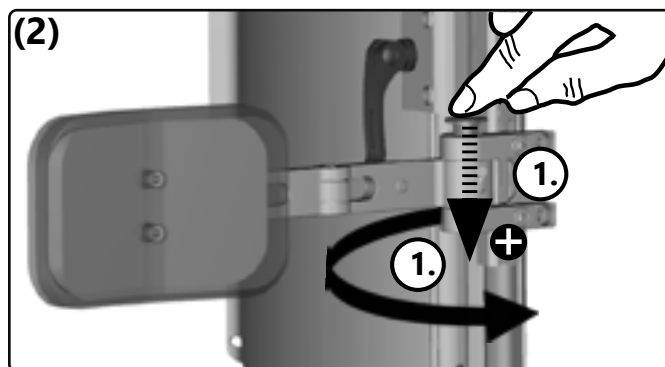
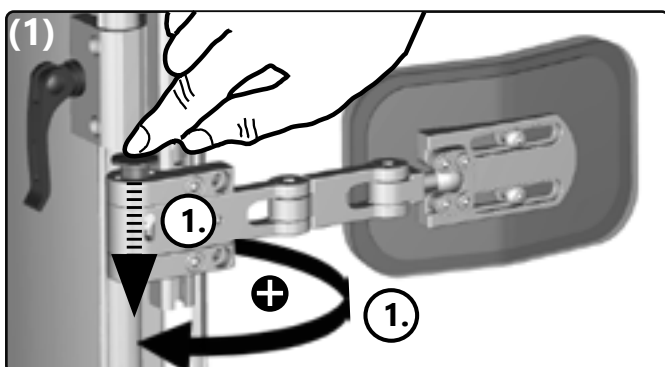

3.10 Handling outdoor-front-end

3.10.1 General indications

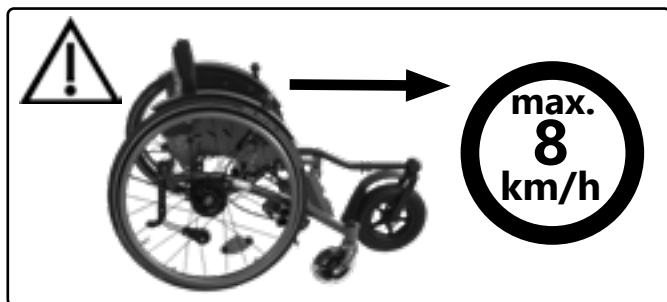

⚠ Please note the max. load of the wheelchair, this also applies to the outdoor-front-end.

mounting (dismounting: In picture 4 proceed in opposite direction):

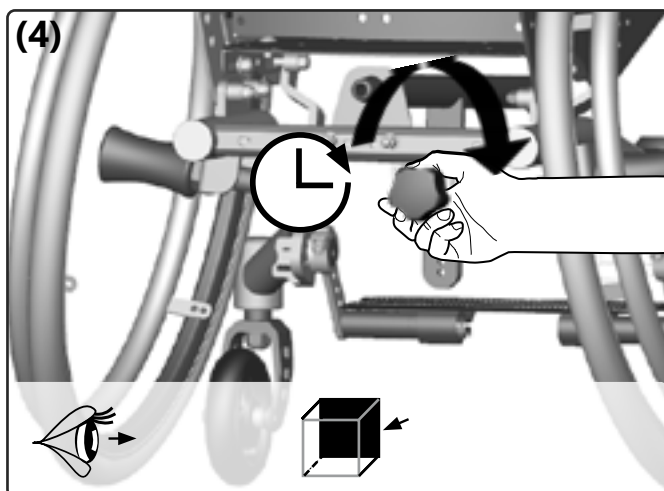
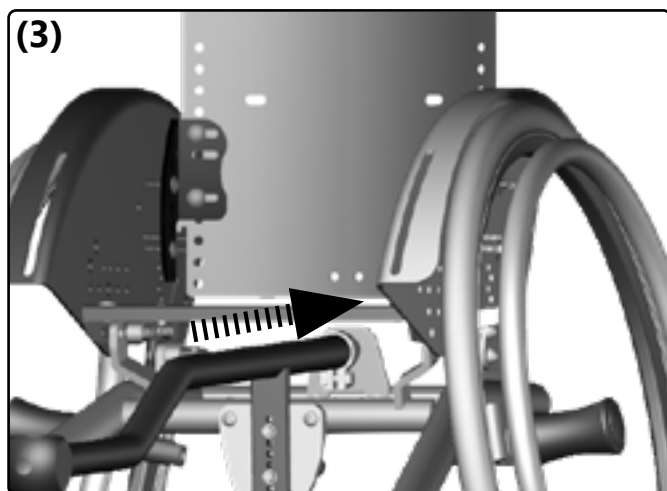
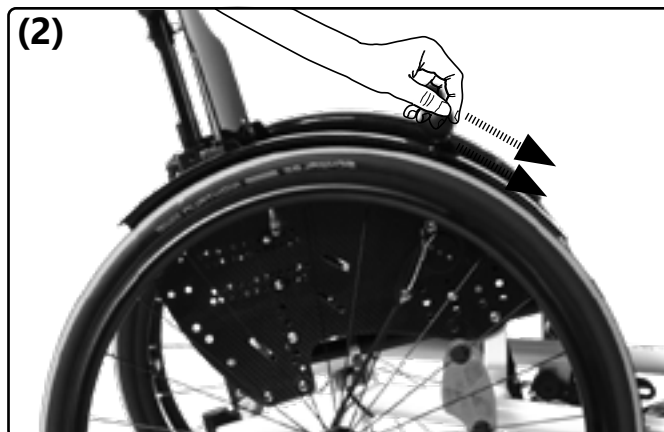

3.11 Handling sun shade

3.11.1 General indications

The sun shade can heat up to 42° with strong sun light.

Never carry the wheelchair over an obstacle by the sun shade.

The sun shade does not protect against rain.

fold up (fold out: proceed analogously in reverse order):

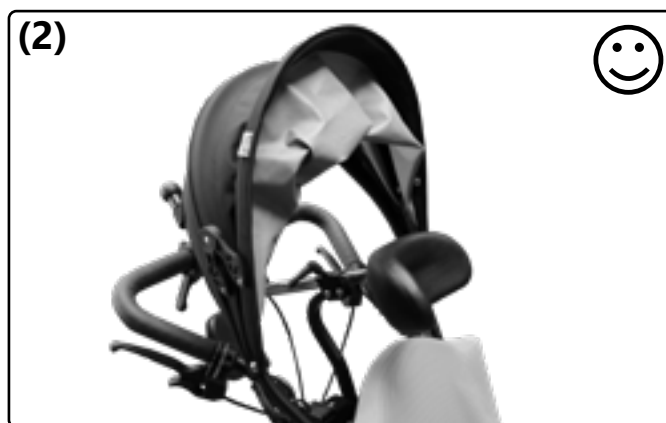

take off (put on: proceed analogously in reverse order):

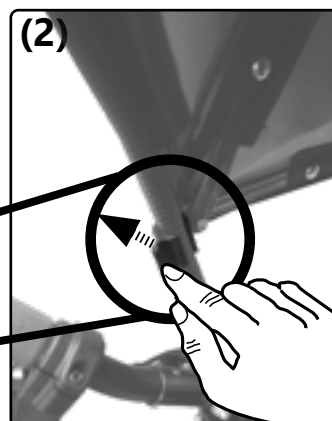
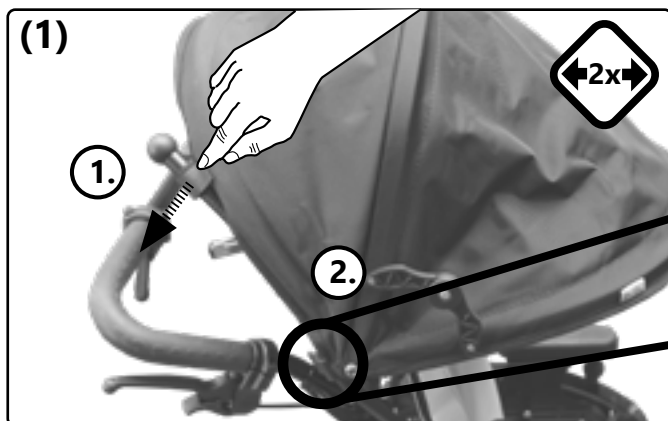

4 Repair/maintenance/reinstatement

4.1 Repairs

Repairs are to be done by your specialized retailer.

4.2 Spare parts

Only original spare parts can be used! They are available at your medical supply store.

The spare parts list can be downloaded at www.sorgrollstuhltechnik.de or can be requested directly from us.

For a correct delivery of spare parts the appropriate serial number of the wheelchair is to be stated. You will find the number on the type label on the wheelchair's frame.

4.3 Maintenance

Clean the wheelchair and all components regularly with a mild household water-based cleaner and then dry it thoroughly.

In addition, clean the rear wheels and the casters and free the axles of dirt and impurities e.g. hair etc.).

Wash textile parts:
Care directions:



Wipe off pleather, straps and other upholstery:
Care directions:



4.4 Disinfection

Before each disinfection the parts should be cleaned off first. For disinfection use a household water-based agent. Observe the instructions of the respective manufacturer.

4.5 Storage

- Carry out cleaning
- Fold foldable wheelchair (if available)
- Adjust seat tilt to 90° (if available)
- If necessary, pack removable textile parts in foil or similar
- Secure the wheelchair from rolling away and getting dirty
- Store in a dry environment without aggressive environmental influences.

4.6 Lifespan

The expected lifespan, depending on the intensity of use and the number of re-uses, is 5 years. For this purpose, the product must be used within the intended purpose and intended use, the instructions in the instructions for use must be followed and all maintenance and service intervals must be observed.

The product can be used beyond this period if it is in a safe condition. This theoretical lifespan is not a guaranteed lifespan and is subject to a case-by-case check by specialist retailers, as is reusability.

Use beyond the specified lifespan leads to an increase in residual risks and should only be carried out after careful and qualified consideration by the operator.

The lifespan can also be shortened depending on the frequency of use, the environment and care. The usual service life does not refer to wear parts such as textile parts, wheels and plastic parts that are subject to material-specific aging and / or wear. This specified service life does not constitute an additional guarantee or guarantee.

4.7 Reinstatement

Before reuse, a full inspection according to the checklist must be carried out by a specialized retailer. All disinfection measures for reuse must be carried out according to a validated hygiene plan.

4.8 Disposal

The wheelchair may only be disposed of with the approval of the benefactor. Disposal of the wheelchair must be in accordance with the applicable national regulations.

4.9 Maintenance/Inspection

For safety reasons and to maintain product liability, an inspection by your retailer is required at least once a year. This must be carried out and documented according to the following checklist.

4 Repairs/maintenance/reinstatement

Checklist maintenance and care (user)

 A poor or neglected maintenance of the wheelchair represents a significant safety risk.

Before each use:

Please check:

- frame, back tubes, mounting parts and accessories for visible damages, deflections, cracks or missing/loose screws,
- wheels/quick release axles for firm fit,
- the airpressure of the tires, tire tread,
- the function of the brakes,
- firm fit of the angle adjustments/eccentric clamps,
- firm fit of seat plate/back/foot plate,
- the function of the anti-tipper/seat and back straps,
- if all previously dismantled parts are put on again or firmly locked.

Every 3 months:

(depending on use, earlier)

Please check:

- screws for firm fitting
- welds, attachments and accessories for hidden damages, deflections or cracks
- tire tread
- the firm fit of third-party systems (if available)

Clean the wheelchair and oil all moving parts.

 If you notice any defects during maintenance, please contact your specialist retailer immediately and do not use the wheelchair anymore.

Checklist yearly inspection (specialized retailer)

Template (available for download at www.sorgrollstuhltechnik.de/downloadportal)

Preparatory Work

- cleaning done

Check:

- Frame, back, mounted parts and accessories checked for damage, bends, cracks and corrosion,
- all fixing screws checked for firm fit and completeness,
- casters and rear wheels as well as the associated attachments checked for good condition, functionality and proper running qualities,
- spokes checked for firm fit and completeness,
- brakes cleaned and maintained,
- Locking mechanisms (tripod springs of push handles, quick-release axles, eccentric clamps, etc.) checked for functionality,
- anti-tipper checked for firm fit and functionality.

Oiling:

- moving parts and bearings oiled

Final check:

- functional check of all mechanical adjusting devices carried out.

5 Technical data

5.1 Data and measurements

Model: Mio Carbon (Design 2018)

Type: 1673

All measurements $\pm 5\%$

Indication	Measurements		Comment
seat width (SW)	20-mm-intervals	180 to 300 mm	+20 mm growable
seat depth (SD)	20-mm-intervals	180 to 300 mm	± 40 mm growable
back height (BH)	50-mm-intervals	175 to 350 mm	+50 mm growable
camber	9°	(optional 7/11°)	
upper edge seat to upper edge footrest	retro-frame:	100-300 mm	without seat cushion!
	taurus-frame:	150-350 mm	
hand rim diameter	with 18" (430 mm)	400 mm	
	with 20" (510 mm)	444 mm	
	with 22" (559 mm)	481 mm	
	with 24" (610 mm)	533 mm	
upper edge seat to ground	with 18"	315 – 360 mm	without seat cushion!
	with 20"	340 – 400 mm	
	with 22"	360 – 420 mm	
	with 24"	385 – 445 mm	
ETRTO wheel size	with 18"	Ø 406 mm	customary tires in sizes 1" (25,4mm), 1 3/8" (35mm) - sizes 355 mm (20"), 451 mm (22"), 540 mm, (24"). All puncture proof in the stated measurements.
	with 20"	Ø 451 mm	
	with 22"	Ø 489 mm	
	with 24"	Ø 540 mm	
absolute width of wheelchair	min.	SB + 310 mm	
	max.	SB + 365 mm	
absolute length of wheelchair	with 18"	605 mm	without push handles!
	with 20"	630 mm	
	with 22"	695 mm	
	with 24"	745 mm	
absolute height of wheelchair	min.	500 mm	without push handles!
	max.	850 mm	
incline	max. permitted	12,3% = 7°	
descent	max. permitted	12,3% = 7°	
stability	max. permitted	12,3% = 7°	
turning circle		ca. 950 mm	
load capacity (max.)	50 kg	user and all attachment parts (shell, truss pads, therapy table, head rest etc.)	
empty weight min. with SW 18 mm, SD 200 mm, 18" wheels, 5" PU casters	5,9 kg	equipped with: frame, rear wheels, hand rims, casters, parking brake, foot plate, side guards, clothes guards and anti-tipper.	
wheels	standard wheels, light weight wheels	optional light weight-drum brake-wheels	
casters:	4", 5"	transparent with LED, solid rubber black with aluminum rims, polyurethane grey with synthetic rim	
tire pressure:	Information on the tire casing (6-8 bar)		
support point:	back frame tube		
heaviest piece:	rear wheels 0,8-1,4 kg		
length of use of the wheelchair	3 years	at not excessive demand	
life cycle of the wheelchair	5 years		
normative requirements	The wheelchair meets the requirements of ISO 7176-8 and the requirements against ignition.		

5 Technical data

5.2 Meaning of labels

The meaning of the individual labels is explained in the texts at the respective place.

If the type plate is damaged or gets lost, a new one can be ordered from SORG Rollstuhltechnik.

Type plate:

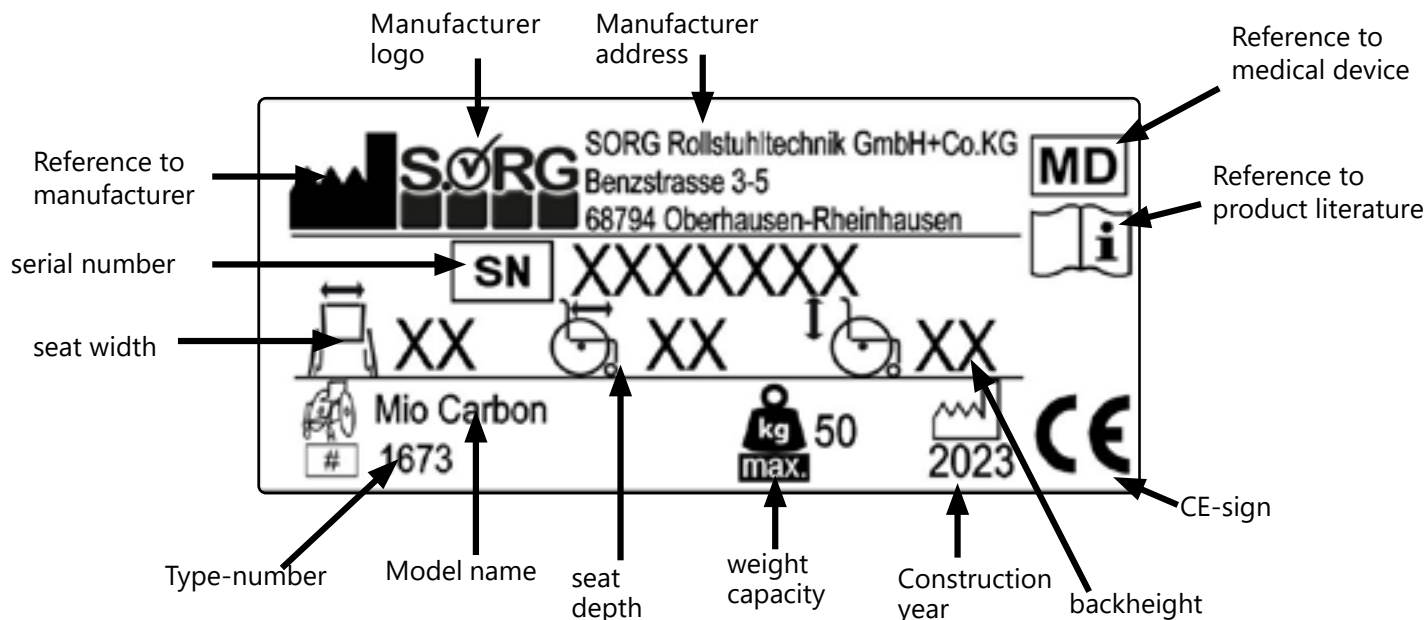

5.3 Declaration of conformity

SORG Rollstuhltechnik declares that the product Mio (Design 2018) a class 1 device is and it complies with the EU regulation (EU) 2017/745 on medical devices.

This was confirmed by a conformity assessment procedure according to the medical Product Guidelines.



If the product is not modified with SORG wheelchair technology, this declaration will lose its validity.

5.4 Guarantee

In addition to our general terms and conditions, we provide a guarantee on frames (for manufacturing and material defects) of two years.

We do not assume any warranty or guarantee for damage resulting from improper assembly/adjustment and/or repairs, neglect and wear and tear as well as changes to assemblies by the user or third parties.

In these cases, product liability expires.

In this respect, we would like to expressly refer again to our specified maintenance intervals under point 4 in our instructions for use.

Please understand that any special constructions and textile parts cannot be exchanged.

6 Verification of yearly inspection

Documentation yearly inspection

For safety reasons and to maintain product liability, an inspection by your retailer is required at least once a year.

Serial number: _____

- yearly inspection conducted according to check list (year 1)

comments:

stamp:

 Date/ Retailer's signature

- yearly inspection conducted according to check list (year 2)

comments:

stamp:

 Date/ Retailer's signature

- yearly inspection conducted according to check list (year 3)

comments:

stamp:

 Date/ Retailer's signature

- yearly inspection conducted according to check list (year 4)

comments:

stamp:

 Date/ Retailer's signature

- yearly inspection conducted according to check list (year 5)

comments:

stamp:

 Date/ Retailer's signature

Instructions for use Mio (Design 2018)



SORG Rollstuhltechnik GmbH + Co. KG
Benzstraße 3-5
68794 Oberhausen-Rheinhausen
Germany
Tel +49 7254 9279-0
Fax +49 7254 9279-10

info@sorgrollstuhltechnik.de
www.sorgrollstuhltechnik.de



company stamp